



ICP-AES & ICP-MS SAMPLE INTRODUCTION

SCP SCIENCE is a manufacturer and supplier of all forms of sample introduction equipment and supplies. Intended as replacements for your OEM components, **SCP SCIENCE** products are guaranteed to meet, or exceed the OEM specifications. Many new and innovative products are also available which enhance signal, lower background noise and improve detection limits. ICP-AES / ICP-MS products include a variety of nebulizers for different applications, replacement torches, spray chambers, peristaltic pump tubing, ICP-MS cones, and a complete range of ICP-AES / ICP-MS Calibration Standards.

72 ICP-AES / ICP-MS Torches & Spray Chambers

- 73 Agilent® (HP®)
- 74 Agilent® (Varian®)
- 78 Horiba® (Jobin Yvon®)
- 80 Teledyne Leeman Labs® (Leeman®)
- 81 PerkinElmer®
- 91 Spectro Analytical
- 94 Shimadzu®
- 94 Thermo®
- 99 Analytika Jena® (Varian®)

100 HF Resistant Sample Introduction

102 ICP-AES / ICP-MS Nebulizers

- 102 Cross Flow
- 103 Concentric
- 105 Quick Connect Kit
- 106 Parallel Path Burgener
- 107 Modified Lichte
- 107 Noordemer and V-Groove

108 ICP-MS Cones

111 Pump Tubing

- 111 Mixing Kits
- 112 Chemical Resistance
- 113 PVC
- 115 Solvent Flex
- 117 Santoprene
- 118 Viton
- 119 Silicone

120 Autosampler Tubes

ICP SAMPLE INTRODUCTION

*Are you trying to get the best performance from your ICP OES/MS?
Looking for alternatives to high-priced OEM components?*

Try some of the New and Innovative products that SCP SCIENCE has to offer!

Ask your Sales Representative, and don't forget to inquire about our FREE promotional items!

TEFLON® INSERT FOR CYCLONIC SPRAY CHAMBER

Battling against residue build-up inside the spray chamber is a familiar exercise for the experienced ICP analyst. This residue is the perfectly normal build-up that occurs during hours of operation, and results in ever-increasing background noise. To combat this, the most efficient technique is acid-bath immersion. Of course the O-rings of a traditional cyclonic spray chamber can make this difficult for fear of their degradation.

Enter the Teflon insert!

SCP SCIENCE has developed a unique Teflon® insert to replace the conventional O-ring spray chamber / nebulizer interface. The insert can then be fully removed, allowing the analyst to immerse the spray chamber in the solution of their choice, successfully removing any residue.

Features

- Special groove to allow for easy nebulizer removal
- A second groove to facilitate removal from the spray chamber
- A notch to prevent liquid build-up, thereby reducing signal spike during analysis

THE ALUMINA INJECTOR FIXED TORCHES

Tired of swapping out sample introduction components to suit variations in your acid matrix? The **SCP SCIENCE** proprietary and complete inert sample introduction system is for you!

Beginning with our famous Mini X-Flow nebulizer, followed by a 100% Ultem cyclonic spray chamber (both described in detail in the following pages) the chain is complete with the **SCP SCIENCE** patented ICP torch with a fixed alumina injector.

Features

- Eliminate the need to switch torches or injectors based on presence of HF
- Eliminate concentricity issues to injector alignment with an O-ring-free fixed torch
- Less manipulation, longer life
- Economically priced
- All standard injector sizes available



FREE PROMOTIONAL ITEM

WITH EVERY SPRAY CHAMBER OR TORCH!

CONTACT OUR SALES DEPARTMENT

FOR MORE INFORMATION SALES@SCPSCIENCE.COM

ICP Sample Introduction (Spray Chambers & Torches)

AGILENT® (HP®)

SPRAY CHAMBERS & ACCESSORIES

Description	OEM X-ref Number	Catalog No.
Cyclonic Spray Chamber, 50ml, Ultem, 12/5 joint, 4mm drain, PTFE Insert	---	020-051-111
Cyclonic Spray Chamber, 50ml, Ultem, baffle, 12/5 joint, 4mm drain, PTFE Insert	---	020-051-211
Cyclonic Spray Chamber, 50 ml, Borosilicate, w/ baffle	---	020-056-104
Cyclonic Spray Chamber, 50 ml, Quartz, w/ baffle	---	020-056-124
Scott Spray Chamber, Borosilicate, Drain & Exit 180°	---	020-050-131
Scott Spray Chamber, Quartz, Drain & Exit 180°	---	020-050-132
Scott Spray Chamber, Quartz, Drain & Exit 90°	G182065337 /G328080008	020-056-101
Scott Spray Chamber, Borosilicate, Drain & Exit 90°	G182065336	020-056-123
Scott Spray Chamber, Quartz, Drain & Exit 90°, Inner tube extended	G182065339	020-056-102
Socket Adapter, Quartz	---	020-050-134
Ball Adapter, Quartz	---	020-050-138
End cap for Babbington, Teflon	G183365476	020-050-151
Ball & Socket Adaptor	G183365426	020-050-272



Spray Chamber,
Scott Quartz
020-056-101

TORCHES & ACCESSORIES

Description	OEM X-ref Number	Catalog No.
Torch, Fixed, 1.5mm, 12/5 joint	G183365424	020-056-002
Torch, Fixed, 2.5mm, 12/5 joint	G183365423 / G327067002	020-050-161
Torch, Demountable Inert	G183365422	020-050-270
Torch, Demountable w/2 Injectors	G327080043	020-050-219
Injector, Alumina	---	020-050-003
Injector, Quartz	---	020-056-051
Injector Holder, Teflon	G182065015	020-050-136
Quartz Connector for Optional gas	G183365427	020-053-375
Quartz Bonnet (pk/2)	G183365421 /G183380040	020-056-052

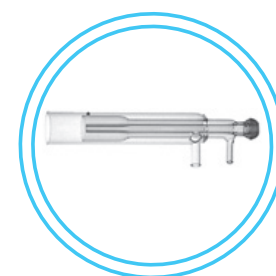

Torch, Fixed
2.5mm, 12/5 joint
020-050-161

ICP Sample Introduction (Spray Chambers & Torches)

AGILENT® (VARIAN®)

AXIAL SPRAY CHAMBERS & ACCESSORIES



Cyclonic Spray Chamber,
50ml Borosilicate
[020-054-160](#)

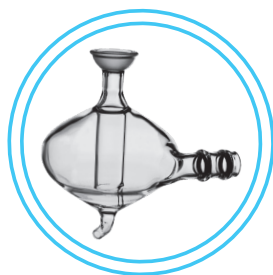

Cyclonic Spray Chamber,
50ml Borosilicate
[020-050-174](#)

Description	OEM X-ref Number	Catalog No.
Cyclonic Spray Chamber, 20ml, Borosilicate, 8mm exit, 4mm drain	208090183	020-054-166
Cyclonic Spray Chamber, 20ml, Borosilicate, 8mm exit, 4mm drain, PTFE Insert	---	020-054-168
Jacketed Cyclonic Spray Chamber, 20ml, Borosilicate, 8mm exit, 4mm drain, PTFE Insert	208090129	020-054-170
Cyclonic Spray Chamber, 50ml, Ultem , 12/5 joint, 4mm drain, PTFE Insert	---	020-051-111
Cyclonic Spray Chamber, 50ml, Ultem, baffle, 12/5 joint, 4mm drain, PTFE Insert	---	020-051-211
Adapter, Spray Chamber to Injector, 8mm O.D, 12/5 joint, Ultem	---	020-050-452
Cyclonic Spray Chamber, 50ml, Borosilicate, baffle, 12/5 joint, 4mm drain	---	020-050-174
Cyclonic Spray Chamber, 50ml, Borosilicate, 8mm exit, 4mm drain	208090600 / 2010081700	020-054-160
Cyclonic Spray Chamber, 50ml, Borosilicate, 8mm exit, 4mm drain, PTFE Insert	208090600 / 2010081700	020-054-162
Cyclonic Spray Chamber, 50ml, Borosilicate, baffle, 8mm exit, 4mm drain, PTFE Insert	7910043700	020-054-314
Jacketed Cyclonic Spray Chamber, 50ml, Borosilicate, 4mm drain, PTFE Insert	208090129	020-054-164

ICP Sample Introduction (Spray Chambers & Torches)

AGILENT® (VARIAN®)

AXIAL TORCHES & ACCESSORIES

Description	OEM X-ref Number	Catalog No.
Torch, Fixed, Axial, 2.4mm	2010081200	020-052-002
Torch, Fixed, Axial, 90° bend, 0.8mm	2010104700	020-054-082
Torch, Fixed, Axial, 90° bend, 1.4mm	---	020-054-122
Torch, Fixed, Axial, 90° bend, 1.4mm, 12/5 joint	2010104800	020-054-224
Torch, Fixed, Axial, 90° bend, 2.0mm Alumina injector.	---	020-070-010
Torch, Fixed, Axial, 90° bend, 2.2mm w/ Sheath Gas	2010122400	020-054-123
Torch, Fixed, Axial, 90° bend, 2.3mm, 12/5 joint	7910050700	020-054-225
Torch, Fixed, Axial, 90° bend, 2.4mm	2010090400 / 2010104600	020-054-125
Torch, Fixed, Axial, 90° bend, 2.4mm, Long Life	---	020-054-128
Torch, Fixed, Axial, 90° bend, 2.4mm, Organics	2010094800	020-054-080
Torch Body, Axial	2010083400	020-052-300
Injector, Quartz, 0.8 mm (pk/3)	2010077500	020-052-301
Injector, Quartz, 1.8mm	2010073000	020-050-144
Injector, Alumina, 1.8mm	2410067500	020-050-145
Injector, Alumina, 2.5 mm	---	020-052-346
Injector Tube Holder, PTFE	9910057300	020-050-199
Kit - Torch, Axial, Demountable, HF Resistant (020-052-300, 020-050-145, 020-050-199)	9910084700	020-052-003
Adapter, Quartz, 206mm straight, 12/5 joints, male- male	7910052800	020-050-194
Adapter, Teflon, 12/5 male for tubing	---	020-048-319
Torch Bonnet, (PK of 2)	2010070700	020-050-143
Sheath Gas Port, 12/5 joints, male-in, female-out	---	020-054-306

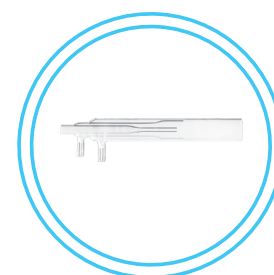

Torch, Axial, Varian®
2.4mm injector.
[020-052-002](#)

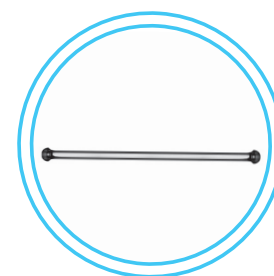



Quartz Adapter,
206mm straight
[020-050-194](#)

ICP Sample Introduction (Spray Chambers & Torches)

AGILENT® (VARIAN®)

RADIAL SPRAY CHAMBERS & ACCESSORIES

	Description	OEM X-ref Number	Catalog No.
 <p>Spray Chamber, Cyclonic 50ml Borosilicate 020-054-160</p>	Cyclonic Spray Chamber, 50ml, Ultem, 12/5 joint, 4mm drain, PTFE Insert	---	020-051-111
	Cyclonic Spray Chamber, 50ml, Ultem, baffle, 12/5 joint, 4mm drain, PTFE Insert	---	020-051-211
	Adapter, Spray Chamber to Injector, 8mm O.D, 12/5 joint, Ultem	---	020-050-452
	Cyclonic Spray Chamber, 20ml, Borosilicate, 8mm exit, 4mm drain	208090183	020-054-166
	Cyclonic Spray Chamber, 20ml, Borosilicate, 8mm exit, 4mm drain, PTFE Insert	---	020-054-168
	Mini Cyclonic Spray Chamber, 20ml, Quartz, Baffle, 8mm exit, 4mm drain Requires separate PTFE Insert (020-049-312)	---	020-049-310
	PTFE Insert, for 20ml spray chamber	---	020-049-312
	Jacketed Cyclonic Spray Chamber, 20ml, Borosilicate, 8mm exit, 4mm drain, PTFE Insert	208090129	020-054-170
	Cyclonic Spray Chamber, 50ml, Borosilicate, 8mm exit 4mm drain	208090600 / 2010081700	020-054-160
	Cyclonic Spray Chamber, 50ml, Quartz, 8mm exit, 4mm drain	---	020-054-161
 <p>Cyclonic Spray Chamber Insert-50 ml Borosilicate 020-054-162</p>	Cyclonic Spray Chamber, 50ml, Borosilicate, baffle, 12/5 joint, 4mm drain	7910043700	020-050-174
	Cyclonic Spray Chamber, 50ml, Quartz, Baffle, 8mm exit, 4mm drain	---	020-054-159
	Cyclonic Spray Chamber, 50ml, Borosilicate, 8mm exit, 4mm drain, PTFE Insert	208090600 / 2010081700	020-054-162
	Cyclonic Spray Chamber, 50ml, Borosilicate, baffle, 8mm exit, 4mm drain, PTFE Insert	7910043700	020-054-314
	Cyclonic Spray Chamber, 50ml, Borosilicate, baffle, 12/5 joint, 4mm drain, PTFE Insert	---	020-054-074
	Jacketed Cyclonic Spray Chamber, 50ml, Borosilicate, 4mm drain, PTFE Insert	208090129	020-054-164

ICP Sample Introduction (Spray Chambers & Torches)

AGILENT® (VARIAN®)

RADIAL TORCHES & ACCESSORIES

Description	OEM X-ref Number	Catalog No.
Torch, Fixed, Radial, 0.8mm	2010117400	020-050-340
Torch, Fixed, Radial, 0.8mm, 12/5 joint	2010069690B	020-050-002
Torch, Fixed, Radial, 1.4mm, 12/5 female joint	2010117500	020-054-234
Torch, Fixed, Radial, 1.5mm, 12/5 female joint	7910052900	020-054-236
Torch, Fixed, Radial, 1.6mm	2010069690	020-050-140
Torch, Fixed, Radial, 1.8mm	2010095000	020-050-133
Torch, Fixed, Radial, 2.3mm, 12/5 female joint	---	020-054-235
Torch, Extended for Nitrogen	2010076400	020-052-001
Torch Body, Radial	2010072900	020-050-142
Injector, Quartz, 0.8 mm (pk/3)	2010077500	020-052-301
Injector, Quartz, 1.8mm	2010073000	020-050-144
Injector, Alumina, 1.8mm	2410067500	020-050-145
Injector, Alumina, 2.5 mm	---	020-052-346
Injector Tube Holder, PTFE	9910057300	020-050-199
Kit - Torch, Radial, Demountable, Insert (020-050-142, 020-050-145, 020-050-199)	9910056800	020-050-130
Adapter, Quartz, 160mm straight, 12/5 joints, male-male	7910052700	020-050-209
Torch Bonnet, (PK of 2)	2010070700	020-050-143

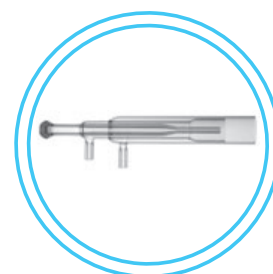

Torch, Fixed, Radial,
0.8 mm, 12/5 joint
020-050-002

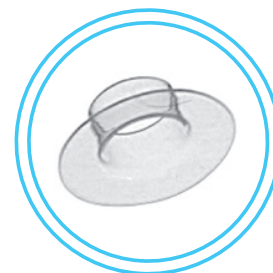

Bonnet, (PK of 2)
020-050-143



FREE PROMOTIONAL ITEM

WITH EVERY SPRAY CHAMBER OR TORCH!

CONTACT OUR SALES DEPARTMENT

FOR MORE INFORMATION SALES@SCPSCIENCE.COM

ICP Sample Introduction (Spray Chambers & Torches)

HORIBA® (JOBIN YVON®)

SPRAY CHAMBERS & ACCESSORIES



U-Drain Trap
Ground Joint
020-053-108



PTFE Insert
for Cyclonic Spray Chamber
020-053-316

Description	OEM X-ref Number	Catalog No.
Cyclonic Spray Chamber, 50ml, Ultem, 12/5 joint, 4mm drain, PTFE Insert	---	020-051-111
Cyclonic Spray Chamber, 50ml, Ultem, baffle, 12/5 joint, 4mm drain, PTFE Insert	---	020-051-211
Cyclonic Spray Chamber, 50ml, Borosilicate, 12/5 joint, 4mm Drain, PTFE insert	47929056	020-053-106
Cyclonic Spray Chamber, 50ml, Borosilicate, 12/5 joint, 4mm Drain	---	020-060-129
Cyclonic Spray Chamber, 50ml, Borosilicate, Axial	---	020-053-100
Cyclonic Spray Chamber, 50ml, Borosilicate, Baffle, 12mm Drain	---	020-050-177
Cyclonic Spray Chamber, 50ml, Ground joint drain	---	020-053-107
Cyclonic Spray Chamber, 50ml, Borosilicate, Baffle, 12/5 joint, 4mm Drain	31030809	020-060-124
Cyclonic Spray Chamber, 50ml, Borosilicate, Baffle, 12/5 joint, 4mm Drain, Requires separate PTFE Insert (020-049-316)	---	020-071-081
Cyclonic Spray Chamber, 50ml, Borosilicate, 12/5 joint, 4mm Drain Requires separate PTFE Insert (020-049-316)	---	020-071-082
PTFE Insert for Cyclonic Spray Chamber	---	020-049-316
Scott Spray Chamber, Borosilicate, 12/5 joint, 12mm Drain	---	020-053-101
Scott Spray Chamber, Quartz, 12/5 joint, 12mm Drain	---	020-053-102
Scott Spray Chamber, Borosilicate, 12/5 joint, 4mm Drain	---	020-053-103
Scott Spray Chamber, Quartz, 12/5 joint, Ground joint drain	---	020-053-104
Scott Spray Chamber, Borosilicate, 12/5 joint, 12mm Drain, for 6mm Nebulizer	---	020-053-105
Scott Spray Chamber, Borosilicate, Ground joint	31026996	020-050-036
Teflon Adapter for JY with Radial Socket	31021730	020-051-404
U-Drain Trap, Ground joint	31026997	020-053-108
Teflon End cap, for use with Scott Spray Chamber and 6mm Nebulizers	---	020-060-601

ICP Sample Introduction (Spray Chambers & Torches)

HORIBA® (JOBIN YVON®)

TORCHES & ACCESSORIES

Description	OEM X-ref Number	Catalog No.
Torch, Fixed, Quartz, 1.5mm 12/5 joint	49010100	020-053-001
Torch kit, Demountable, Quartz, Complete	21356110	020-053-002
Torch, Body, Demountable	---	020-053-301
Torch Tube, Outer, Radial, Quartz, 71mm	31023722	020-050-037
Torch Tube, Outer, Radial, Quartz, 82.5mm	---	020-053-302
Torch Tube, Outer, Axial, Quartz 105 mm	31031099	020-053-303
Torch Tube, Quartz, Inner	31023723	020-050-038
Torch Centering Ring, Teflon	31023724	020-050-039
Injector, Quartz	---	020-050-175
Injector, Quartz, 3.0mm	---	020-050-510
Injector, Alumina, 3.1mm	31021589	020-050-041
Injector, Alumina 3.1mm w/ PTFE Holder	21356130	020-050-084
Injector Tube Holder, PTFE	31021730	020-050-040
Sheath Gas, PEEK, w/ Quick Conn.	20925160	020-053-376
Sheath Gas, Borosilicate, 12/5 joint, with Quick Conn.	---	020-053-377
Sheath Gas, Borosilicate, w/ Quick Conn.	21356040	020-050-176
O-ring for Injector (pk5)	---	020-050-506
O-ring Kit (pk8)	---	020-050-507
O-ring for Teflon Insert (5)	---	020-050-508
O-ring for Torch Body (pk4)	46702525	020-053-201
Torch, Extension	---	020-053-378
Torch, Bonnet (pk2)	49010101	020-053-379

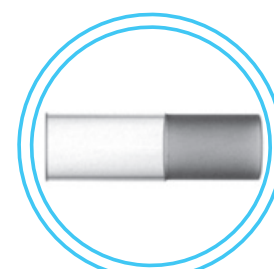

Torch Tube,
Quartz, Outer
[020-050-037](#)

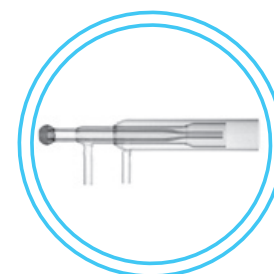

Torch, Fixed, Quartz,
1.5 mm, 12/5 Joint
[020-053-001](#)

ICP Sample Introduction (Spray Chambers & Torches)

TELEDYNE LEEMAN LABS (LEEMAN®)

SPRAY CHAMBERS & ACCESSORIES



Jacketed Cyclonic Spray Chamber, Borosilicate
020-051-125

Description	OEM X-ref Number	Catalog No.
Cyclonic Spray Chamber, 50ml, Ultem, No Baffle, PTFE Insert	---	020-051-111
Cyclonic Spray Chamber, 50ml, Ultem, baffle, 12/5 joint, 4mm drain, PTFE Insert	---	020-051-211
Mini-Cyclonic Spray Chamber, 20 ml, Borosilicate, 12/5 joint, PTFE Insert	---	020-051-105
Cyclonic Spray Chamber, 50ml, Axial, Borosilicate, Baffle, 4mm Drain, requires separate PTFE Insert (020-049-316)	---	020-071-041
PTFE Insert for Cyclonic Spray Chamber	---	020-049-316
Jacketed Cyclonic Spray Chamber, Borosilicate, 50ml, 12/5 joint, 4mm Drain	---	020-051-125
Scott Spray Chamber, Radial	1203751/3180017	020-050-055

TORCHES & ACCESSORIES

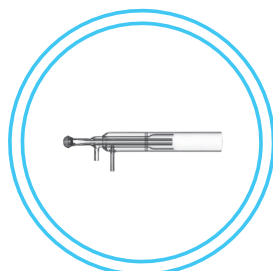

Torch, Fixed
2.5mm (straight bore)
020-054-055

Description	OEM X-ref Number	Catalog No.
Torch, Fixed, RADIAL, 12/5 joint, Aqueous	120003361/1203748	020-050-053
Torch, Fixed, RADIAL, 12/5 joint, Organics	120003362/1203749	020-050-054
Torch, Fixed, 1.0mm, Beveled End	3180016	020-050-050
Torch, Fixed, Tandem, Aqueous, 1.5mm	31800026	020-050-056
Torch, Fixed, Tandem, Organic, 1.0mm	31800027	020-050-057
Torch, Fixed, Organic, 12/5 joint, w/fittings	120003362	020-050-262
Torch, Fixed, 2.5mm, 12/5 joint, w/fittings	120003363	020-050-083
Torch, Fixed, 2.5mm (straight bore), 12/5 joint, w/fittings	120003091	020-054-055
Torch, Fixed, Axial, Aqueous, 12/5, 190mm	31800062	020-054-057
Torch, Fixed, Aqueous, Dual View, DRE, 2.5mm	31800065	020-054-002
Torch Body, Radial	1203017/3180001	020-050-059
Torch Body, Axial	31800069	020-054-056
Torch Body, DV, Demountable	31800070	020-054-003
Injector, Quartz, Capillary	---	020-050-052
Injector, Quartz, 1.2mm	3180004	020-050-060
Torch Body, Aqueous, w/Injector	1203010	020-050-058
Quartz Opt Window/Purge Tube	1210034	020-050-178
Argon Hose with Fittings	3093311	020-054-065
Tube, Purge, V2, DV	31800067	020-054-302
Purge Tube for Radial	31800068	020-054-301

ICP Sample Introduction (Spray Chambers & Torches)

PERKINELMER® OPTIMA 3000 SERIES RL, SCR

SPRAY CHAMBERS & ACCESSORIES

Description	OEM X-ref Number	Catalog No.
Cyclonic Spray Chamber, 50ml, Borosilicate, Baffle, 4mm drain	---	020-051-116
Cyclonic Spray Chamber, 50ml, Ultem, Baffle, 12/5 joint, 4mm drain, PTFE Insert	---	020-051-211
Cyclonic Spray Chamber, 50ml, Borosilicate, Baffle, 4mm drain	---	020-060-128
Cyclonic Spray Chamber, 50ml, Radial, Borosilicate, Baffle, 4mm drain - For use with MLN	---	020-060-132
Cyclonic Spray Chamber, 50ml, Borosilicate, Baffle, 12/5 joint, 4mm drain, requires separate PTFE Insert (020-049-316)	N0771501	020-071-031
PTFE Insert for Cyclonic Spray Chamber	---	020-049-316
Scott Spray Chamber, Borosilicate, Type II	---	020-050-211
Drain Kit, 12mm (Scott)	WE013119	020-050-089

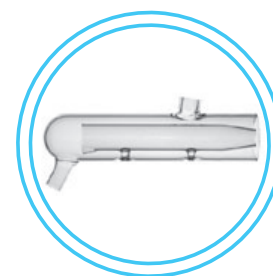

Scott Spray Chamber,
Borosilicate, Type II
020-050-211

TORCHES & ACCESSORIES

Description	OEM X-ref Number	Catalog No.
Torch, Fixed, 1 slot, Alumina, 2.0mm	---	020-070-005
Torch Body	N0690568	020-050-181
Torch Body, Wear Metals	---	020-050-186
Injector, Quartz, 1.2mm	N0681631	020-050-182
Injector, Quartz, 1.2 mm, Organics	---	020-054-503
Injector, Quartz, 1.6mm	N0695448	020-050-238
Injector, Quartz, 2.0mm	N0695441	020-050-234
Injector, Alumina, 0.85 mm	N8126039	020-051-316
Injector, Alumina, 1.5 mm	N0582185	020-051-314
Injector, Alumina, 2.0 mm	N8126041	020-050-256
Torch Bonnet, (pk2)	N0695295	020-050-185
Torch Bonnet, Flat Edge (pk2)	N0695456	020-050-204
O-ring Kit for Optima Torch (pk5)	N0690269	020-050-523
O-ring Kit, PE®3000 (pk5)	---	020-051-324
Purge Extension Window UV	N0581497	020-050-213

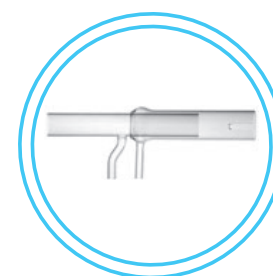

Torch Body
020-050-181

ICP Sample Introduction (Spray Chambers & Torches)

PERKINELMER® OPTIMA 3000 SERIES XL, SCX

SPRAY CHAMBERS & ACCESSORIES

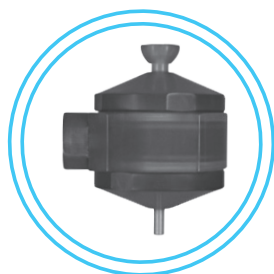

Spray Chamber
Cyclonic Ultem
020-051-111

Description	OEM X-ref Number	Catalog No.
Cyclonic Spray Chamber, 50ml, Ultem, 12/5 joint, 4mm drain, PTFE Insert	---	020-051-111
Cyclonic Spray Chamber, 50ml, Ultem, Baffle, 12/5 joint, 4mm drain, PTFE Insert	---	020-051-211
Adaptor, Ultem, 12mm torch to 12/5 jointed Spray chamber	---	020-050-454
Cyclonic Spray Chamber, 50ml, Borosilicate, 11.3mm exit, 4mm drain, PTFE insert	N8120150	020-051-141
Cyclonic Spray Chamber, 50ml, Quartz, 11.3mm exit, 4mm drain, PTFE insert	N8122188	020-051-140
Jacketed Cyclonic Spray Chamber, 50ml, Borosilicate, Baffle, 11.3mm exit, 4mm drain	---	020-051-134
Cyclonic Spray Chamber, 50ml, Borosilicate, 12mm exit, 4mm drain	N8122188	020-050-109
Cyclonic Spray Chamber, 50ml, Borosilicate, Baffle, 12mm exit, 4mm drain	---	020-050-248
Cyclonic Spray Chamber, 50ml, Borosilicate, Baffle, 12mm exit, 4mm drain, Requires separate PTFE Insert (020-049-316)	N0776053	020-071-021
Cyclonic Spray Chamber, 50ml, Borosilicate, 12mm exit, 4mm drain, Requires separate PTFE Insert (020-049-316)	N0776052	020-071-022
PTFE Insert for Cyclonic Spray Chamber	---	020-049-316

TORCHES & ACCESSORIES

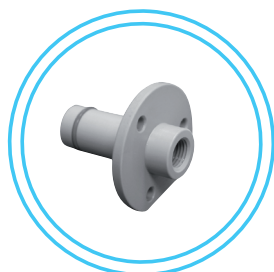

Injector Support Adapter,
PEEK, for Scott Spray chamber
020-050-425

Description	OEM X-ref Number	Catalog No.
Torch, Fixed, Alumina, 2.0mm	---	020-070-020
Torch, Fixed, 1-slot, Alumina, 2.0mm	---	020-070-005
Torch body	N0695379	020-050-202
Injector, Quartz, 0.8mm	---	020-050-243
Injector, Quartz, 1.2mm	N0695460	020-050-242
Injector, Quartz, 1.2mm Oil	---	020-054-513
Injector, Quartz, 1.6mm	N0695449	020-050-240
Injector, Quartz, 2.0mm	N0695442	020-050-203
Injector, Quartz, 2.0mm, 109mm length	N0695442	020-050-241
Injector, Alumina, 2.0mm	N0695362	020-050-252
Injector Support Adapter, PEEK, for Scott Spray Chamber	N0695400	020-050-425
Injector Support Adapter, PEEK, for 12mm torch, Cyclonic Spray Chamber	---	020-050-435
Injector Support Adapter, PEEK, for 12/5 socketed torch, Cyclonic Spray Chamber	---	020-050-445
Injector Support Adapter, PEEK, for 11.3mm torch, Cyclonic Spray chamber	N0690780	020-050-450
Adaptor, Ultem, 12mm torch to 12/5 jointed Spray chamber	---	020-050-454
Axial View Purge Extension Window	9992731	020-050-221
Bonnet, Dual View, (2)	N0691664	020-050-207
O-ring Kit for PE® Optima DV	N0690769	020-051-311

ICP Sample Introduction (Spray Chambers & Torches)

PERKINELMER® OPTIMA 3000 SERIES DV

SPRAY CHAMBERS & ACCESSORIES

Description	OEM X-ref Number	Catalog No.
Cyclonic Spray , 50ml, Ultem, 12/5 joint, 4mm drain, PTFE Insert	---	020-051-111
Cyclonic Spray Chamber, 50ml, Ultem, Baffle, 12/5 joint, 4mm drain, PTFE Insert	---	020-051-211
Adaptor, PEEK, 12mm torch to 12/5 jointed spray chamber	---	020-050-455
Adaptor, Ultem, 12mm torch to 12/5 jointed spray chamber	---	020-050-454
Cyclonic Spray Chamber, 50ml, Borosilicate, 11.3mm exit, 4mm drain, PTFE insert	N8120150	020-051-141
Cyclonic Spray Chamber, 50ml, Quartz, 11.3mm exit, 4mm drain, PTFE insert	N8122188	020-051-140
Jacketed Cyclonic Spray Chamber, 50ml, Borosilicate, Baffle, 11.3mm exit, 4mm drain	---	020-051-134
Cyclonic Spray Chamber, 50ml, Borosilicate, 12mm exit, 4mm drain	N8122188	020-050-109
Cyclonic Spray Chamber, 50ml, Borosilicate, Baffle, 12mm exit, 4mm drain	---	020-050-248
Cyclonic Spray Chamber, 50ml, tBorosilicate, 12mm exit, for use with MLN	---	020-050-250
Cyclonic Spray Chamber, 50ml, Borosilicate, Baffle, 12mm exit, 4mm drain, Requires separate PTFE Insert (020-049-316)	N0776053	020-071-021
Cyclonic Spray Chamber, 50ml, Borosilicate, 12mm exit, 4mm drain, Requires separate PTFE Insert (020-049-316)	N0776052	020-071-022
PTFE Insert for Cyclonic Spray Chamber	---	020-049-316

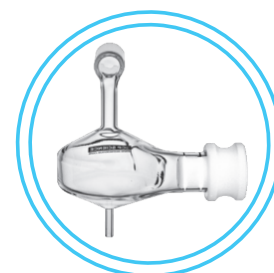

Spray Chamber,
Cyclonic, Borosilicate
[020-051-141](#)

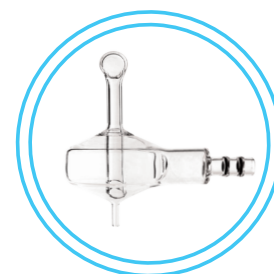

Spray Chamber,
Cyclonic, Borosilicate
[020-050-248](#)

ICP Sample Introduction (Spray Chambers & Torches)

PERKINELMER® OPTIMA 3000 SERIES DV

TORCHES & ACCESSORIES



Radial Purge Extension
Quartz Window, Optima 3000 DV
020-050-206

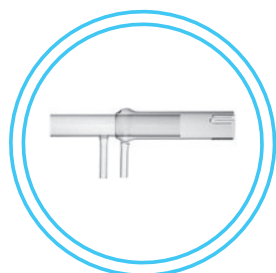

Torch Body, 3-Slots
020-050-249

Description	OEM X-ref Number	Catalog No.
Torch, Fixed, 1-slot, Alumina, 2.0mm	---	020-070-005
Torch Body, 1-slot	N0691662	020-050-246
Torch Body, 1-slot, Wear Metals	---	020-050-247
Torch Body, 2-slots	---	020-050-200
Torch Body, 3-slots	---	020-050-249
Injector, Quartz, 0.8mm	---	020-050-243
Injector, Quartz, 1.2mm	N0695460	020-050-242
Injector, Quartz, PE® 1.2mm Oil	---	020-054-513
Injector, Quartz, 1.6mm	N0695449	020-050-240
Injector, Quartz, 2.0mm	N0695442	020-050-203
Injector, Alumina, 2.0mm	N0695362	020-050-252
Injector Support Adapter, PEEK, for Scott Spray Chamber	N0695400	020-050-425
Injector Support Adapter, PEEK, for 12mm torch, Cyclonic Spray Chamber	---	020-050-435
Injector Support Adapter, PEEK, for 11.3mm torch, Cyclonic Spray Chamber	N0690780	020-050-450
Adaptor, Ultem, 12mm torch to 12/5 jointed Spray Chamber	---	020-050-454
O-ring Kit for PE® Optima DV	N0690769	020-051-311
Radial Purge Extension Quartz Window, Optima 3000 DV	N0691689	020-050-206
Axial View Purge Extension Window, Optima 3000DV	N0691678	020-050-208
Bonnet, Dual View, (2)	N0691664	020-050-207



FREE PROMOTIONAL ITEM

WITH EVERY SPRAY CHAMBER OR TORCH!

CONTACT OUR SALES DEPARTMENT

FOR MORE INFORMATION SALES@SCPSCIENCE.COM

ICP Sample Introduction (Spray Chambers & Torches)

PERKINELMER® OPTIMA 2X00/4X00/5X00/7X00 DV SERIES

SPRAY CHAMBERS & ACCESSORIES

Description	OEM X-ref Number	Catalog No.
Cyclonic Spray Chamber, 50ml, Ultem, 12/5 joint, 4mm drain, PTFE Insert	---	020-051-111
Cyclonic Spray Chamber, 50ml, Ultem, Baffle, 12/5 joint, 4mm drain, PTFE Insert	---	020-051-211
Adaptor, PEEK, 12mm torch to 12/5 jointed spray chamber	---	020-050-455
Adaptor, Ultem, 12mm torch to 12/5 jointed spray chamber	---	020-050-458
Mini Cyclonic Spray Chamber, 20ml, Borosilicate, 12/5 joint, 4mm drain	---	020-051-107
Cyclonic Spray Chamber, 50ml, Quartz, 12mm exit, 4mm drain, PTFE insert	N0776052Q	020-051-154
Cyclonic Spray Chamber, 50ml, Borosilicate, Baffle, 12mm exit, 4mm drain, PTFE insert	N0776090	020-051-138
Cyclonic Spray Chamber, 50ml, Borosilicate, Baffle, 12mm exit, 4mm drain, Requires separate PTFE Insert (020-049-316)	N0776053	020-071-021
Cyclonic Spray Chamber, 50ml, Borosilicate, 12mm exit, 4mm drain, Requires separate PTFE Insert (020-049-316)	N0776052	020-071-022
PTFE Insert for Cyclonic Spray Chamber	---	020-049-316
Teflon Adaptor, PE® 2000/4000	---	020-051-409

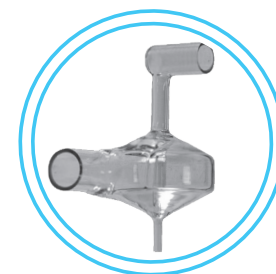

Spray Chamber,
Cyclonic, Borosilicate
[020-051-138](#)

CAN'T FIND WHAT YOU'RE LOOKING FOR?
consult our website at
WWW.SCPSCIENCE.COM

ICP Sample Introduction (Spray Chambers & Torches)

PERKINELMER® OPTIMA 2X00/4X00/5X00/7X00 DV SERIES

TORCHES & ACCESSORIES



Radial Purge Extension Window (short tube)
020-050-254

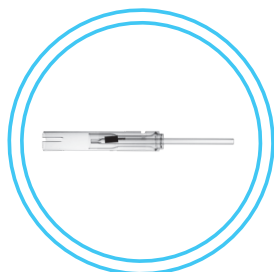

Torch, Fixed, 1-slot, Quartz
020-051-007

Description	OEM X-ref Number	Catalog No.
Torch, Fixed, 1-slot, Quartz, 0.8mm	---	020-051-007
Torch, Fixed, 1-slot, Quartz, 1.2mm	---	020-051-008
Torch, Fixed, 1-slot, Quartz, 1.6mm	---	020-051-009
Torch, Fixed, 1-slot, Quartz, 2.0mm	---	020-051-004
Torch, Fixed, 1-slot, Alumina, 1.2mm	---	020-070-016
Torch, Fixed, 1-slot, Alumina, 2.0mm	---	020-070-022
Torch Body, 0-slot	N0770343	020-051-006
Torch Body, 0-slots, Short Version, PE® 2x00/4x00/5x00/7x00 DV	N0770344	020-051-098
Torch Body, 1-slot	N0770338	020-051-002
Torch Body, 3-slots, for PE® 2x00/4x00/5x00/7x00 DV	N0772005	020-051-010
Injector, Quartz, 0.8mm	N0775225	020-051-310
Injector, Quartz, 1.0mm, w/o Taper	---	020-051-323
Injector, Quartz, 1.2mm	N0775226	020-051-308
Injector, Quartz, 1.6mm	N0775223	020-051-306
Injector, Quartz, 2.0mm	N0775014	020-051-302
Injector, Quartz, 3.0mm	N0775224	020-051-304
Injector, Alumina, 0.8mm	N0775227	020-051-317
Injector, Alumina, 1.2mm	N0775228	020-051-318
Injector, Alumina, 1.2mm, PE®4x00 Axial	N0776093	020-054-515
Injector, Alumina, 2.0mm	N0775177	020-051-319
Injector, Alumina, 2.0mm, 87mm length	---	020-051-322
Injector Support Adapter, Fixed Torch, 12mm Spray chamber exit	---	020-050-426
Copper Strip (pk/12)	N0775297	020-051-001
O-ring, Kit for Torch	N0770437	020-050-513
Radial Purge Extension Window (short tube)		020-050-254
Radial Purge Extension Window	N0770322	020-051-256
Radial Purge Tube Window, Frosted	N0770944	020-051-258
Axial View Purge Extension Window	9992731	020-050-221
Torch Bonnet (pk2)	N0775289	020-051-350

ICP Sample Introduction (Spray Chambers & Torches)

PERKINELMER® OPTIMA 4300V / 5300V / 7300V SERIES

SPRAY CHAMBERS & ACCESSORIES

Description	OEM X-ref Number	Catalog No.
Cyclonic Spray Chamber, 50ml, Ultem, 12/5 joint, 4mm drain, PTFE Insert	---	020-051-111
Cyclonic Spray Chamber, 50ml, Ultem, Baffle, 12/5 joint, 4mm drain, PTFE Insert	---	020-051-211
Adaptor, PEEK, 12mm torch to 12/5 jointed spray chamber	---	020-050-455
Adaptor, Ultem, 12mm torch to 12/5 jointed spray chamber	---	020-050-454
Cyclonic Spray Chamber, 50ml, Quartz, Baffle, 12/5 joint, 4mm drain, Requires separate PTFE Insert (020-049-316)	---	020-071-131
Cyclonic Spray Chamber, 50ml, Borosilicate, Baffle, 12/5 joint, 4mm drain, Requires separate PTFE Insert (020-049-316)	N0771501	020-071-031
Cyclonic Spray Chamber, 50ml, Borosilicate, 12/5 joint, 4mm drain, Requires separate PTFE Insert (020-049-316)	---	020-071-032
PTFE Insert for Cyclonic Spray Chamber	---	020-049-316



Spray Chamber, Cyclonic
020-071-031

SPRAY CHAMBERS & ACCESSORIES

Description	OEM X-ref Number	Catalog No.
Torch, Fixed, 1 slot, Alumina, 2.0mm	---	020-070-005
Torch Body, 3-slots	N0771500	020-051-005
Injector, Quartz, 0.8mm, Organics	N0695461	020-054-517
Injector, Quartz, 1.2mm	N0695460	020-050-242
Injector, Quartz, 1.6mm	N0695449	020-050-240
Injector, Quartz, 1.8mm	---	020-051-312
Injector, Quartz, 1.8mm, 83 Length	---	020-051-307
Injector, Quartz, 2.0 mm	N0695442	020-050-203
Injector, Alumina, 1.2mm	N0771531	020-050-258
Injector, Alumina, 2.0mm	N0695362	020-050-252
O-ring for Injector (pk5)	---	020-050-514
O-ring Kit for Torch	N0770916	020-050-516
Purge Extension Window UV	N0581497	020-050-213

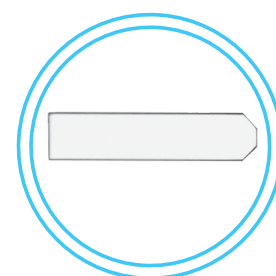

Purge Extension Window
020-050-513

ICP Sample Introduction (Spray Chambers & Torches)

PERKINELMER® OPTIMA 8300-DV

SPRAY CHAMBERS, TORCHES & ACCESSORIES

Description	OEM X-ref Number	Catalog No.
Cyclonic Spray Chamber, 50ml, Ultem, 12/5 joint, 4mm drain, PTFE Insert	---	020-051-111
Cyclonic Spray Chamber, 50ml, Ultem, Baffle, 12/5 joint, 4mm drain, PTFE Insert	---	020-051-211
Cyclonic Spray Chamber, 50ml, Borosilicate, 12mm exit, 4mm drain, Requires separate PTFE Insert (020-049-316)	N0776052	020-071-022
Cyclonic Spray Chamber, 50ml, Borosilicate, Baffle, 12mm exit, 4mm drain, Requires separate PTFE Insert (020-049-316)	N0776053	020-071-021
PTFE Insert for Cyclonic Spray Chamber	---	020-049-316
Cyclonic Spray Chamber, 50ml, Borosilicate, Baffle, 12mm exit, 4mm drain, with PTFE insert	N0776090	020-051-138
Cyclonic Spray Chamber, 50ml, Borosilicate, Baffle, 12/5 joint, 4mm drain, with PTFE insert	N0771501	020-051-126
Mini Cyclonic Spray Chamber, 20ml, Borosilicate, 12/5 joint, 4mm drain	---	020-051-107
Torch Body, 8X00 DV, 1 slot for PE®	N0780130	020-051-015
Torch Body, 8X00 DV, 3 slot for PE®	N0780132	020-051-014
Injector, Quartz, 0.8mm	N0781018	020-051-332
Injector, Quartz, 1.2mm	N0781019	020-051-333
Injector, Quartz, 1.6mm	N0781016	020-051-334
Injector, Quartz, 2.0mm	N0781050	020-051-335
Injector, Quartz, 3.0mm	N0781017	020-051-336
Injector, Alumina, 0.8mm	N0781009	020-051-330
Injector, Alumina, 1.2mm	N0781015	020-051-331
Injector, Alumina, 2.0mm	N0781014	020-051-326

CAN'T FIND WHAT YOU'RE LOOKING FOR?
consult our website at
WWW.SCPSCIENCE.COM

ICP Sample Introduction (Spray Chambers & Torches)

PERKINELMER® ELAN 5000/6000/9000 SERIES

SPRAY CHAMBERS & ACCESSORIES

Description	OEM X-ref Number	Catalog No.
Cyclonic Spray Chamber, 50ml, Ultem, 12/5 joint, 4mm drain, PTFE Insert	---	020-051-111
Cyclonic Spray Chamber, 50ml, Ultem, Baffle, 12/5 joint, 4mm drain, PTFE Insert	---	020-051-211
Cyclonic Spray Chamber, 50ml, Borosilicate, 11.3mm exit, 4mm drain	N8120150	020-051-119
Cyclonic Spray Chamber, 50ml, Borosilicate, 11.3mm exit, 4mm drain, PTFE Insert	N8120150	020-051-141
Cyclonic Spray Chamber, 50ml, Quartz, 11.3mm exit, 4mm drain	---	020-051-120
Cyclonic Spray Chamber, 50ml, Quartz, 12/5 joint, 4mm drain	---	020-051-011
Cyclonic Spray Chamber, 50ml, Quartz, Baffle, 12/5 joint, 4mm drain	WE025221	020-051-136
Cyclonic Spray Chamber, 50ml, Quartz, Baffle, 12/5 joint, 4mm drain, PTFE Insert	WE025221	020-051-132
Jacketed Cyclonic Spray Chamber, 50ml, Quartz, 4mm drain	---	020-051-121
Scott Spray Chamber, Borosilicate, 12/5 joint, gravity drain	---	020-050-073
Scott Spray Chamber, Quartz, 12mm exit, gravity drain	---	020-050-074
Jacketed Scott Spray Chamber, Borosilicate, 12/5 joint, gravity drain	---	020-050-075
Gravity drain kit for Scott Spray Chamber	WE013119	020-050-089



Jacketed Cyclonic
Spray Chamber
020-051-121

TORCHES & ACCESSORIES

Description	OEM X-ref Number	Catalog No.
Torch, Fixed, Quartz, 12/5 joint	472048	020-051-003
Torch, Fixed, Quartz, Short (135mm)	N8102001	020-050-070
Torch, Fixed, Quartz, Long (150mm)	---	020-050-071
Torch Body, Type I	N0580233	020-050-064
Torch Body, 0-slot	N8122006	020-050-072
Injector, Quartz, 1.2 mm	N0681631	020-050-182
Injector, Quartz, 1.6 mm	473292	020-050-183
Injector, Quartz, 2.0 mm	N8125029	020-050-184
Injector, Quartz, 2.0mm - Type I	---	020-050-010
Injector, Alumina, 1.5mm	N0582185	020-051-314
Injector, Alumina, 2.0 mm	N0582184 / N8126041	020-050-256
Injector Support/Torch Base	N8120116 / N8122007	020-051-353
Torch O-ring kit, ELAN (pk4)	N8120100	020-051-096
Torch Extension, Slotted	---	020-050-061
Torch Extension, w/ optical port	---	020-051-305
Torch Purge Tube	473187	020-050-218
Torch Purge Tube, for Slotted Extension	473561	020-050-217
Torch Bonnet, Type 1 (pk2)	472033	020-051-309



Bonnet for Torch
Type 1
020-051-309

ICP Sample Introduction (Spray Chambers & Torches)

PERKINELMER® ELAN 6100DRC, DRC II, DRC-E

SPRAY CHAMBERS & ACCESSORIES



Scott Spray Chamber,
Quartz
020-050-074

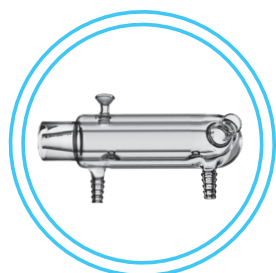

Jacketed Scott,
Spray Chamber
020-050-075

Description	OEM X-ref Number	Catalog No.
Cyclonic Spray Chamber, 50ml, Ultem, 12/5 joint, 4mm drain, PTFE Insert	---	020-051-111
Cyclonic Spray Chamber, 50ml, Ultem, Baffle, 12/5 joint, 4 mm drain, PTFE Insert	---	020-051-211
Cyclonic Spray Chamber, 50ml, Borosilicate, 11.3 mm exit, 4 mm drain	N8120150	020-051-119
Cyclonic Spray Chamber, 50ml, Borosilicate, 11.3 mm exit, 4mm drain, PTFE Insert	N8120150	020-051-141
Cyclonic Spray Chamber, 50ml, Borosilicate, Baffle, 11.3mm exit, 4mm drain Requires separate PTFE Insert (020-049-316)	N8120150	020-071-051
PTFE Insert for Cyclonic Spray Chamber	---	020-049-316
Cyclonic Spray Chamber, 50ml, Quartz, 11.3mm exit, 4mm drain	---	020-051-120
Cyclonic Spray Chamber, 50ml, Quartz, Baffle, 12/5 joint, 4 mm drain	WE025221	020-051-136
Cyclonic Spray Chamber, 50ml, Quartz, Baffle, 12/5 joint, 4mm drain, PTFE Insert	WE025221	020-051-132
Mini-Cyclonic Spray Chamber, 20ml, Borosilicate, 12/5 joint, 4 mm drain	---	020-051-106
Jacketed Cyclonic Spray Chamber, 50ml, Quartz, 4 mm drain	---	020-051-121
Scott Spray Chamber, Borosilicate, 12/5 joint, gravity drain	---	020-050-073
Scott Spray Chamber, Quartz, 12 mm exit, gravity drain	---	020-050-074
Jacketed Scott Spray Chamber, Borosilicate, 12/5 joint, gravity drain	---	020-050-075
Gravity drain kit for Scott Spray Chamber	WE013119	020-050-089

TORCHES & ACCESSORIES

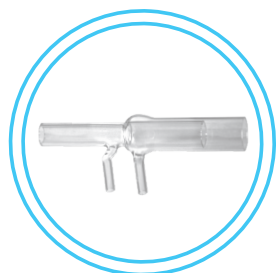

Torch Body, 0-slot, O-ring free
020-050-087

Description	OEM X-ref Number	Catalog No.
Torch Body, 0-slot	N8122006	020-050-072
Torch Body, 0-slot, O-ring free	ES11021000	020-050-087
Torch Body, 0-slot, High Efficiency	W1008384	020-050-462
Torch, Fixed, Quartz, Long (151mm)	---	020-051-099
Injector, Quartz, 2.0mm	WE023948	020-051-355
Injector, Quartz, 1.5mm	WE027005	020-051-357
Injector Support, DRC	WE023951	020-051-359

ICP Sample Introduction (Spray Chambers & Torches)

PERKINELMER® NEXION ICP-MS

SPRAY CHAMBERS, TORCHES & ACCESSORIES

Description	OEM X-ref Number	Catalog No.
Cyclonic Spray Chamber, 50ml, Ultem, 12/5 joint, 4mm drain, PTFE Insert	---	020-051-111
Cyclonic Spray Chamber, 50ml, Ultem, Baffle, 12/5 joint, 4mm drain, PTFE Insert	---	020-051-211
Cyclonic Spray Chamber, 50ml, Borosilicate, Baffle, O-ring less, ball-joint, 4mm drain	N8145014	020-070-050
Cyclonic Spray Chamber, 50ml, Quartz, Baffle, O-ring less, ball-joint, 4mm drain	N8145013	020-051-197
Torch Body, 0-slot	N8122006	020-050-072
Injector, Quartz, 1.2 mm	N0681631	020-050-182
Injector, Quartz, 1.6 mm	N0473292	020-050-183
Injector, Quartz, 2.0 mm	N8120529	020-050-184
Injector, Alumina, 0.85 mm	N8126039	020-051-316
Injector, Alumina, 1.5mm	N8126040/N0582185	020-051-314
Injector, Alumina, 2.0 mm	N05282184/N8126041	020-050-256

SPECTRO ANALYTICAL EOP

SPRAY CHAMBERS & ACCESSORIES

Description	OEM X-ref Number	Catalog No.
Cyclonic Spray Chamber, 50ml, Ultem, 12/5 joint, 4mm drain, PTFE Insert	---	020-051-111
Cyclonic Spray Chamber, 50ml, Ultem, Baffle, 12/5 joint, 4mm drain, PTFE Insert	---	020-051-211
Cyclonic Spray Chamber, 50ml, Borosilicate, Baffle, 12/5 joint, 13mm drain	---	020-055-100
Cyclonic Spray Chamber, 50ml, Borosilicate, Baffle, 12/5 joint, 4mm drain, for MLN	---	020-060-126
Cyclonic Spray Chamber, 50ml, Borosilicate, Baffle, 12/5 joint, 13mm drain, for MLN	---	020-060-130
Scott Spray Chamber, Double Pass, Borosilicate, Long 90° exit, 12/5 joint, 8mm drain	48105051	020-055-120
Scott Spray Chamber, Double Pass, Borosilicate, 12/5 joint, 14/20 ground joint drain	48105006	020-050-095

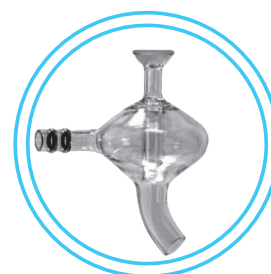

Cyclonic Spray Chamber
Borosilicate
020-055-100

ICP Sample Introduction (Spray Chambers & Torches)

SPECTRO ANALYTICAL EOP

TORCHES & ACCESSORIES

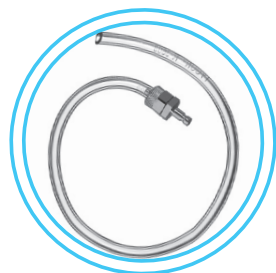

Gas Adaptor Set
for SPECTRO Fixed Torch
020-055-051



HF Holder, SPECTRO
020-050-233

Description	OEM X-ref Number	Catalog No.
Torch, Fixed, Quartz, 1.8mm, 12/5 joint, Flared	48105052A	020-055-013
Torch, Fixed, Quartz, 1.8mm, 12/5 joint, Flared, w/sheath gas	75160549	020-055-015
Torch, Fixed, Quartz, 2.5mm, 12/5 joint, Flared, w/fittings	75160526	020-055-021
Torch, Fixed, Quartz, 2.5mm, 12/5 joint, Flared	44302072 / 44302077 / 48105052	020-050-230
Torch, Fixed, Quartz, 2.5mm, 12/5 joint, Flared, w/sheath gas	75160537	020-050-226
Torch, Fixed, Quartz, 3.0mm, 12/5 joint, Flared, w/sheath gas	75260533	020-050-229
Torch, Fixed, Quartz, 3.2mm, 12/5 joint, Flared, w/sheath gas	---	020-050-264
Torch, Fixed, Alumina, 2.0mm, 12/5 joint, Flared	---	020-070-015
Torch, Fixed, Alumina, 1.2mm, 12/5 joint, Flared	---	020-070-017
Torch Body, Demountable	480206007	020-050-232
Torch Body, Demountable w/GL14 end	48105064 / 75260561	020-055-025
Torch Body, Demountable w/GL14 end, w/1.8mm quartz injector	75260558	020-055-023
Adapter, Alumina, GL14-12/5	44502001	020-055-026
Injector, Quartz, 1.2mm	48105071	020-050-251
Injector, Quartz, 1.5mm, 12/5 joint	48105008	020-050-096
Injector, Quartz, 1.8mm	48105072	020-050-257
Injector, Quartz, 2.5mm	48105073	020-050-253
Injector, Quartz, 2.5mm w/ 12/5 joint	48105058	020-050-260
Injector, Alumina, 1.8mm w/O-ring	48807015	020-050-259
Injector, Alumina, 2.5mm w/O-ring	48807016	020-050-255
HF Holder, SPECTRO	75160538	020-050-233
Adapter, Ultem, 7.0mm i.d. to 6.2mm o.d.	---	020-050-440
Adapter, Spray Chamber to Injector, 8mm O.D., 12/5 joint, Ultem	---	020-050-452
Adapter, Ultem, 6.2mm o.d. to 12/5 joint	---	020-050-459
Adapter Kit for SPECTRO Axial ICP	---	020-051-420
Gas Adaptor Set for SPECTRO Fixed Torch	---	020-055-051
Adapter, Borosilicate, 90°, 90x128mm height, 12/5 female to 12/5 male	48105002	020-055-311
Adapter, Borosilicate, 90°, 38x108mm height, 12/5 female to 12/5 male	48105062	020-060-150

ICP Sample Introduction (Spray Chambers & Torches) SPECTRO ANALYTICAL SOP

SPRAY CHAMBERS & ACCESSORIES

Description	OEM X-ref Number	Catalog No.
Cyclonic Spray Chamber, 50ml, Ultem, 12/5 joint, 4mm drain, PTFE Insert	---	020-051-111
Cyclonic Spray Chamber, 50ml, Ultem, Baffle, 12/5 joint, 4mm drain, PTFE Insert	---	020-051-211
Cyclonic Spray Chamber, 50ml, Borosilicate, Baffle, 12/5 joint, 13mm drain	---	020-055-100
Cyclonic Spray Chamber, 50ml, Borosilicate, Baffle, 12/5 joint, Short O-ring adaptor, 4mm drain	---	020-050-086
Cyclonic Spray Chamber, 50ml, Borosilicate, Baffle, 12/5 joint, 13mm drain, for MLN	---	020-060-130
Cyclonic Spray Chamber, 50ml, Borosilicate, Baffle, 12/5 joint, 4mm drain - long, for MLN	---	020-060-131
Jacketed Cyclonic Spray Chamber, 50ml, Borosilicate, Baffle, 12/5 joint, 4mm drain	---	020-055-121
Scott Spray Chamber, Double Pass, Borosilicate, 12/5 joint, 14/20 ground joint drain	48105006	020-050-095
Scott Spray Chamber, Double Pass, Borosilicate, Long 90° exit, 12/5 joint, 8mm drain	48105051	020-055-120

TORCHES & ACCESSORIES

Description	OEM X-ref Number	Catalog No.
Torch, Fixed, Quartz, 1.0mm, 12/5 joint	48205001	020-055-010
Torch, Fixed, Quartz, 1.8mm, 12/5 joint	75060596	020-050-090
Torch, Fixed, Quartz, 2.5mm, 12/5 joint	---	020-050-092
Torch, Fixed, Alumina, 1.2mm, 12/5 joint	---	020-070-012
Torch, Fixed, Alumina, 1.2mm, 12/5 joint, Spectroflame	---	020-070-014
Torch, Fixed, Alumina, 2.0mm, 12/5 joint	---	020-070-011
Torch, Fixed, Alumina, 2.0mm, 12/5 joint, Spectroflame	---	020-070-013
Torch Body	48206002	020-050-091
Torch Body, w/ GL14	48105068	020-055-024
Injector, Quartz, 1.2mm, w/O-ring	48105071	020-050-251
Injector, Quartz, 1.8mm, w/O-ring	48105072	020-050-257
Injector, Quartz, 1.8mm, 12/5 joint	48105010	020-050-188
Injector, Quartz, 2.5mm, w/O-ring	48105073	020-050-253
Injector, Quartz, 2.5mm, 12/5 joint	48105009	020-050-189
Injector, Alumina, 2.5mm, w/O-ring	48807016	020-050-255
Injector, Alumina, 1.8mm w/O-ring	48807015	020-050-259
Adapter, Spray Chamber to Injector, 8mm O.D, 12/5 joint, Ultem	---	020-050-452
Gas Adaptor Set for SPECTRO Fixed Torch	---	020-055-051
O-ring Kit	---	020-055-321

ICP Sample Introduction (Spray Chambers & Torches)

SHIMADZU®

SPRAY CHAMBERS, TORCHES & ACCESSORIES

Description	OEM X-ref Number	Catalog No.
Cyclonic Spray Chamber, 50ml, Borosilicate, 12/5 joint, 14/20 ground joint drain	460009302	020-054-406
Torch, Fixed, Quartz, 1.0mm, 12/5 joint	20477296	020-054-403
Torch, Fixed, Quartz, 1.5mm, 12/5 joint	20470272	020-054-401
Torch, Fixed, Quartz, 1.8mm, 12/5 joint	20474323	020-054-405

THERMO® (TJA) - 61E, IRIS, INTREPID - RADIAL

SPRAY CHAMBERS & ACCESSORIES

Description	OEM X-ref Number	Catalog No.
Cyclonic Spray Chamber, 50ml, Ultem, 12/5 joint, 4mm drain, PTFE Insert	---	020-051-111
Cyclonic Spray Chamber, 50ml, Ultem, Baffle, 12/5 joint, 4mm drain, PTFE Insert	---	020-051-211
Adaptor, Ultem, for 12/5 joint Spray Chamber to Radial Torch	---	020-050-451
Cyclonic Spray Chamber, 50ml, Borosilicate, 12/5 joint, 4mm drain	---	020-051-129
Cyclonic Spray Chamber, 50ml, Borosilicate, 12/5 joint, 4mm drain, PTFE insert	---	020-051-429
Cyclonic Spray Chamber, 50ml, Borosilicate, 40mm neck, 4mm drain	13966300	020-051-123
Cyclonic Spray Chamber, 50ml, Borosilicate, 40mm neck, 10mm drain	13610500	020-051-108
Cyclonic Spray Chamber, 50ml, Borosilicate, Baffle, 40mm neck, 4mm drain, PTFE insert	---	020-051-030
Cyclonic Spray Chamber, 50ml, Borosilicate, Baffle, 80mm neck, 4mm drain, PTFE insert	---	020-051-101

ICP Sample Introduction (Spray Chambers & Torches)

Thermo® (TJA) - 61E, IRIS, INTREPID - RADIAL

TORCHES & ACCESSORIES

Description	OEM X-ref Number	Catalog No.
Torch, 0-slot, Ceramic Base, High Flow, Quartz Injector, 1.0mm, Organics	12512401	020-050-125
Torch, 0-slot, Ceramic Base, High Flow, Quartz Injector, 1.5mm	12643201	020-050-124
Torch, 0-slot, Ceramic Base, High/Low Flow, Quartz Injector, 1.5mm	12643202	020-050-123
Torch, 0-slot, Ceramic Base, High Flow, Quartz Injector 1.5mm, 1 Red Line	12643203	020-050-192
Torch, 0-slot, Ceramic Base, High Flow, Alumina Injector 1.5mm	12717901	020-049-000
Torch, 1-slot, Ceramic Base, Quartz Injector 1.5mm, 1 Red Line	12643204	020-051-196
Torch Body, 0-slot, Ceramic Base	12644003	020-051-193
Torch Body, 0-slot, Ceramic Base, High Flow	12644001	020-050-137
Torch Outer Tube	14110100	020-057-505
Torch Inner Tube	14110000	020-057-508
Injector, Quartz, 1.0mm, PT2000	14110600	020-057-501
Injector, Quartz, 1.0mm, 2 Red lines, VOC	12540701	020-050-118
Injector, Quartz, 1.5mm, 1 Red line	12540700	020-050-119
Injector, Quartz, 1.8mm, Tapered	14110500	020-057-500
Injector, Quartz, 2.0mm, 1 Blue line	13650201	020-051-340
Injector, Quartz, 2.4mm, 2 Blue lines	13650202	020-051-344
Injector, Alumina, 1.0mm	---	020-049-302
Injector, Alumina, 1.5mm	13643601	020-051-300
Argon Inlet Connector (pk/2)	---	020-051-200
O-ring for TJA Injector Tube	12584700	020-051-346
Anti-Arc Cap	8520700	020-049-303
Anti-Arc Cap, Flat Edge	8520701	020-050-127



Torch, Ceramic Base, High Flow
020-049-000

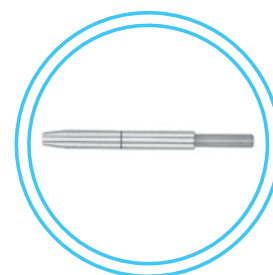

Tip, Injector, Quartz, Aqueous single red
020-050-119



FREE PROMOTIONAL ITEM

WITH EVERY SPRAY CHAMBER OR TORCH!

CONTACT OUR SALES DEPARTMENT

FOR MORE INFORMATION SALES@SCPSOURCE.COM

ICP Sample Introduction (Spray Chambers & Torches)

THERMO® (TJA) - ADVANTAGE, IRIS, INTREPID, TRACE - AXIAL

SPRAY CHAMBERS & ACCESSORIES



Scott Spray Chamber, 19/9 joint-
long neck, 10 mm drain
020-050-113

Description	OEM X-ref Number	Catalog No.
Cyclonic Spray Chamber, 50ml, Ultem, 12/5 joint, 4mm drain, PTFE Insert	---	020-051-111
Cyclonic Spray Chamber, 50ml, Ultem, Baffle, 12/5 joint, 4mm drain, PTFE Insert	---	020-051-211
Cyclonic Spray Chamber, Borosilicate, 50ml, 9.5mm Axial exit, 10mm drain	13462000	020-050-191
Cyclonic Spray Chamber, Borosilicate, 50ml, 9.5mm Axial exit, 4mm drain	13966200	020-051-195
Cyclonic Spray Chamber, Borosilicate, 50ml, 9.5mm Axial exit (100mm), 4mm drain, PTFE insert	14451500	020-051-296
Cyclonic Spray Chamber, Borosilicate, 50ml, 12/5 joint, 4mm drain	---	020-051-129
Cyclonic Spray Chamber, Borosilicate, 50ml, 12/5 joint, 4mm drain, PTFE insert	---	020-051-429
Scott Spray Chamber, Borosilicate, 19/9 joint - long neck, 10mm drain	19040065	020-050-113
Scott Spray Chamber, Borosilicate, 19/9 joint - short neck, 10mm drain	12794700	020-050-114
Baffle, Teflon® for Scott Spray Chamber	---	020-050-069

TORCHES & ACCESSORIES

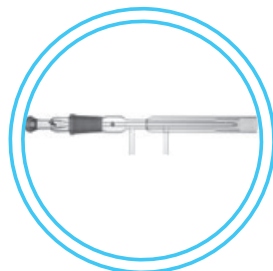

Torch Demountable
with Injector
020-050-111

Description	OEM X-ref Number	Catalog No.
Torch, Fixed, Quartz, Low Flow	---	020-050-121
Torch, Demountable, w/ Quartz injector, 1.0mm	19040054	020-050-110
Torch, Demountable, w/ 2x Quartz injector, 1.0mm	---	020-050-111
Torch Extension, w/optical Port	---	020-049-301
Injector, Quartz, 1.0mm, PT2000	14110600	020-057-501
Injector, Quartz, 1.0mm, 2 Red lines, VOC	12540701	020-050-118
Injector, Quartz, 1.5mm, 1 Red line	12540700	020-050-119
Injector, Quartz, 2.0mm, 1 Blue line	13650201	020-051-340
Injector, Quartz, 2.4mm, 2 Blue lines	13650202	020-051-344
Injector, Alumina, 1.0mm	---	020-049-302
Injector, Alumina, 1.5mm	13643601	020-051-300
Adapter, Ultem, 12/5 Spray Chamber to TJA Axial torch	---	020-050-453
Torch Bonnet (pk2)	19040075	020-049-300

ICP Sample Introduction (Spray Chambers & Torches) THERMO® (TJA) - IRIS DUO

DUO SPRAY CHAMBERS & ACCESSORIES

Description	OEM X-ref Number	Catalog No.
Cyclonic Spray Chamber, 50ml, Ultem, 12/5 joint, 4mm drain, PTFE Insert	---	020-051-111
Cyclonic Spray Chamber, 50ml, Ultem, Baffle, 12/5 joint, 4mm drain, PTFE Insert	---	020-051-211
Cyclonic Spray Chamber, Borosilicate, 50ml, 9.5mm Axial exit, 10mm drain	13462000	020-050-191
Cyclonic Spray Chamber, Borosilicate, 50ml, 9.5mm Axial exit, 4mm drain	13966200	020-051-195
Cyclonic Spray Chamber, Borosilicate, 50ml, 9.5mm Axial exit - 58mm long, 10mm drain	13612000	020-051-112
Cyclonic Spray Chamber, Borosilicate, 50ml, Baffle, 12/5 joint, 4mm drain, PTFE insert	---	020-051-229
Cyclonic Spray Chamber, Borosilicate, 50ml, 12/5 joint, 4mm drain, PTFE insert	---	020-051-429

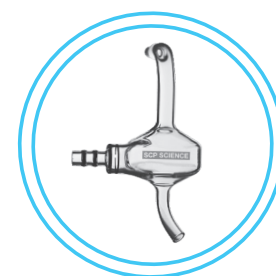

Cyclonic Spray Chamber,
9.5mm Axial exit - 58mm long,
10mm drain
[020-051-112](#)

DUO TORCHES & ACCESSORIES

Description	OEM X-ref Number	Catalog No.
Torch, Ceramic Base, Optical Port, Quartz Injector, 1.5mm	13769400 / 13856200	020-051-192
Torch, Ceramic Base, Optical Port	12644005	020-051-194
Torch Body, PT2000	14278200	020-057-506
Torch Outer Tube, PT2000	14110100	020-057-505
Torch Inner Tube, PT2000	14110000	020-057-508
Injector, Quartz, 1.0mm, PT2000	14110600	020-057-501
Injector, Quartz, Tapered, 1.8mm	14110500	020-057-500
Injector, Quartz, 1.5mm	14385700	020-057-510
Optic Sleeve for DV Torch	13768900 / 13856300	020-049-304
Seal for Optic Sleeve	---	020-049-314



Torch, Ceramic Base,
Optical Port
[020-051-192](#)

ICP Sample Introduction (Spray Chambers & Torches)

THERMO® iCAP™ 6X00

SPRAY CHAMBERS & ACCESSORIES

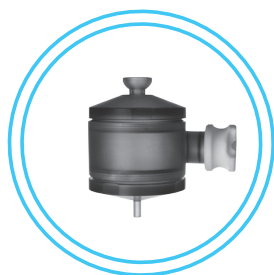

Spray Chamber, Ultem,
Cyclonic, PTFE Insert
020-051-111

Description	OEM X-ref Number	Catalog No.
Cyclonic Spray Chamber, 50ml, Ultem, 12/5 joint, 4mm drain, PTFE Insert	---	020-051-111
Cyclonic Spray Chamber, 50ml, Ultem, Baffle, 12/5 joint, 4mm drain, PTFE Insert	---	020-051-211
Adaptor, 90°, Ultem, 12/5 Spray Chamber to 9.5mm Torch	---	020-050-456
Adapter, Ultem, 12/5 Spray Chamber to Radial Torch	---	020-050-457
Cyclonic Spray Chamber, 50ml, Borosilicate, 18/9 joint, 4mm drain	842312051411	020-050-001
Cyclonic Spray Chamber, 50ml, Borosilicate, Baffle, 18/9 joint, 4mm drain	842312051311	020-049-003
Cyclonic Spray Chamber, 50ml, Borosilicate, 18/9 joint, 4mm drain, Requires separate PTFE Insert (020-049-316)	---	020-071-002
Cyclonic Spray Chamber, 50ml, Borosilicate, Baffle, 18/9 joint, 4mm drain, Requires separate PTFE Insert (020-049-316)	---	020-071-001
PTFE Insert for Cyclonic Spray Chamber	---	020-049-316
Jacketed Cyclonic Spray Chamber, 50ml, Borosilicate, 18/9 joint, 10mm drain	---	020-057-124
Jacketed Cyclonic Spray Chamber, 50ml, Quartz, 18/9 joint, 10mm drain	---	020-057-125
Jacketed Cyclonic Spray Chamber, 50ml, Borosilicate, Baffle, 18/9 joint, 4mm drain	842312051441	020-049-004
Adaptor, 90°, Borosilicate, 18/9 Spray Chamber to 9.5mm Torch	842312051251	020-050-103

TORCHES & ACCESSORIES



Torch, Duo, iCAP™
020-049-001

Description	OEM X-ref Number	Catalog No.
Torch, Duo, iCAP™	842312051241	020-049-001
EMT Torch for iCAP™ 6000 Duo	---	020-049-005
Injector, EMT, 1.5mm	842312051951	020-049-105
Injector, EMT, 2.0mm	842312051971	020-049-106
Injector, EMT, 1.0mm	842312051941	020-049-107
Injector, Alumina EMT, 1.2mm	---	020-049-108
Injector, Alumina EMT, 2.0 mm	---	020-049-109
Injector, Alumina, 2.0	---	020-050-122

ICP Sample Introduction (Spray Chambers & Torches) THERMO® X-SERIES ICP-MS

SPRAY CHAMBERS, TORCHES & ACCESSORIES

Description	OEM X-ref Number	Catalog No.
Jacketed Scott Spray Chamber, Double-pass, Borosilicate, 12/5 joint, gravity drain	4600508	020-050-032
Torch, Fixed, Quartz, 1.5mm, 12/5 joint	3600969	020-056-316
Torch, Fixed, Quartz, 2.0mm, 12/5 joint	3601147	020-056-318
Torch Shield, Quartz	3601149	020-056-311

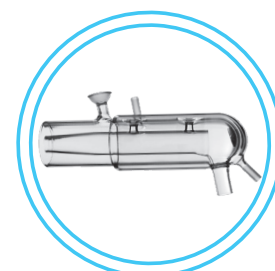

Jacketed Scott
Spray Chamber
020-050-032

ANALYTIK JENA - (VARIAN®) 800-MS SERIES

SPRAY CHAMBERS, TORCHES & ACCESSORIES

Description	OEM X-ref Number	Catalog No.
Cyclonic Spray Chamber, 50ml, Ultem, 12/5 joint, 4mm drain, PTFE Insert	---	020-051-111
Cyclonic Spray Chamber, 50ml, Ultem, Baffle, 12/5 joint, 4mm drain, PTFE Insert	---	020-051-211
Cyclonic Spray Chamber, 50ml, Borosilicate, 8mm exit, 4mm drain Requires separate PTFE Insert (020-049-316)	---	020-071-062
PTFE Insert for Cyclonic Spray Chamber	---	020-049-316
Cyclonic Spray Chamber, 50ml, Borosilicate, Baffle, 8mm exit, 4mm drain, PTFE insert	---	020-054-165
Cyclonic Spray Chamber, 50ml, Quartz, Baffle, 90° 12mm exit, 4mm drain, for use with Pelletier Cooler	---	020-056-300
Scott Spray Chamber, Borosilicate, Double pass, 12/5 joint, 10mm drain	2010101000	020-054-163
Scott Spray Chamber, Quartz, Double pass, 12/5 joint, 7mm drain	---	020-056-126
Torch, Fixed, Quartz, 2.4mm, 12/5 joint	2010100700	020-054-312

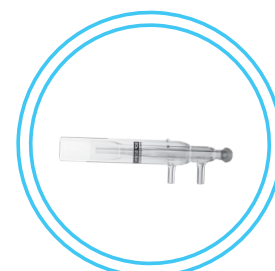

Torch, Fixed,
Quartz
020-054-312

UNIVERSAL SAMPLE INTRODUCTION SYSTEMS

Applications from ultra clean waters to waste waters and rock samples.

MINI X-FLOW UNIVERSAL ICP NEBULIZER

SCP SCIENCE manufactures a full range of glassware and quartzware to keep your ICP-AES/ICP-MS instrument running. New and innovative products are available for enhancing signal, lowering background and improving detection limits.

The Mini X-Flow nebulizer is part of a new family of **SCP SCIENCE** ICP nebulizers, spray chambers and torches offering versatility unmatched in today's analytical market. With the Mini X-Flow nebulizer, one can enjoy optimal performance while, at the same time, eliminate the need to change nebulizer for different sample types.

Whether your samples are clean waters, suspensions, sludges or samples with high dissolved solids, the Mini X-Flow nebulizer can handle them all - with the best performance. Manufactured from acid resistant Ultem plastic and a platinum iridium sample inlet coupled to a sapphire crystal, the Mini X-Flow nebulizer may run samples in any acid matrix (including Hydrofluoric acid). The Mini X-Flow nebulizer is designed to be used with specific Teflon®, insert-ready, **SCP SCIENCE** cyclonic spray chambers.

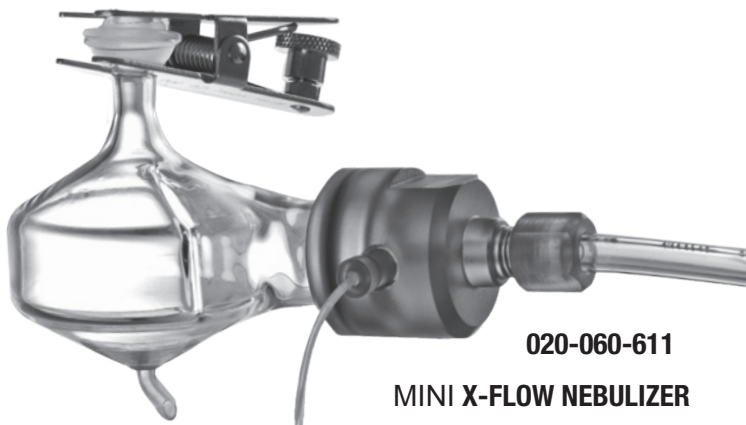

OPERATIONAL SPECIFICATIONS

Sample Flow Rate:	0.8 - 3.0 ml / min
Argon Gas Flow Rate:	1.0L / min
Operating Pressure:	25-40 psi

MINI X-FLOW PERFORMANCE

A comparison of the Mini X-Flow nebulizer detection limits with those of other popular nebulizers. Included in the study were glass concentric and Teflon® parallel path nebulizers. Results show equal to, or better detection limits using the Mini X-Flow nebulizer.

For high solid samples, the Mini X-Flow nebulizer provides excellent performance for solutions containing as high as 30% TDS (Total dissolved solids).

Tests prove the Mini X-Flow's superior performance over a wide range of elements in varying solids concentrations.

Comparison of the Detection Limits for the Mini X-Flow and Other Nebulizers

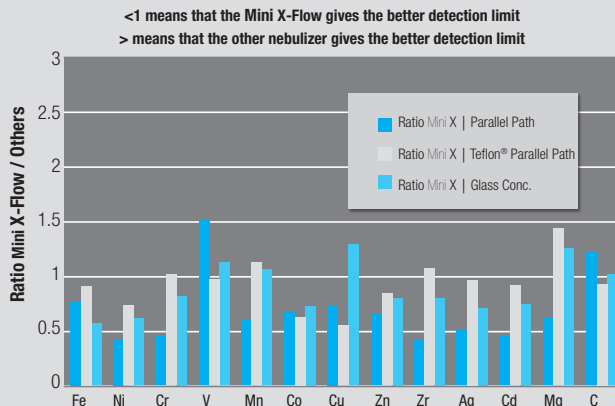

ULTEM SPRAY CHAMBER

The Ultem spray chamber can also be supplied with a Teflon® insert for use with 6 mm diameter concentric or parallel path nebulizers. The Mini X-Flow fits directly onto the spray chamber inlet port. This inert spray chamber is unique because it is made of 3 components (a top cap, middle body, and bottom base) that can be assembled and disassembled easily. This design makes cleaning the spray chamber simple and trouble-free, and permits the user to convert between baffled and non-baffled configurations.

COMPATIBILITY

With the **SCP SCIENCE** Ultem spray chamber, customers enjoy the ultimate in flexibility. By unscrewing the top and bottom, the body can be flipped to convert the spray chamber from left hand nebulizer entry to right hand entry allowing the spray chamber to be used in different manufacturers' instruments in the lab. The top can be converted from baffled to unbaffled by simply switching the top portion of the spray chamber. When the Ultem Spray Chamber is used with the **SCP SCIENCE** Mini X-Flow nebulizer, the pair provides the best choice for HF resistant operation.

ADVANTAGES

Cyclonic spray chambers provide superior wash out times compared to traditional Scott spray chambers. Choose a baffled Spray Chamber for stronger signal or unbaffled for better RSD, or both by purchasing the spray chamber with both top configurations!



ULTEM SPRAY CHAMBER

020-051-111

Complete Spray Chamber	Top Only
without baffle - 020-051-111	without baffle - 020-051-214
with baffle - 020-051-211	with baffle - 020-051-215

ALUMINA INJECTOR TORCHES

Beginning with our famous Mini X-Flow nebulizer, followed by a 100% Ultem cyclonic spray chamber, the final component of the chain is the **SCP SCIENCE** patented ICP torch with a fixed HF-resistant alumina injector. Designed to save the user time and money through extended torch life, and by eliminating the need to interchange injectors.



For SPECTRO Users
020-070-015



For PerkinElmer® Users
020-070-010



For Varian® Users
020-070-005

Nebulizer

CROSS-FLOW

Features

Compatible with a variety of glass and HF resistant cyclonic spray chambers for use with PerkinElmer®, TJA, Varian® and SPECTRO ICP-OES & ICP-MS spectrometers.

Manufactured from acid resistant Ultem plastic

Ideal for high solids applications

Up to 30% TDS

The Mini X-Flow and standard Cross Flow nebulizers are traditional choices for high solids or otherwise dirty samples. Ultem construction with sapphire (aluminum oxide crystal) argon jet and platinum-iridium sample port allows the use of most solutions including HF.

The standard Cross Flow fits Scott spray chambers with a 35mm opening, while the Mini X-Flow is designed for cyclonic spray chambers. See page 100 for more details on our innovative Mini X-Flow and our complete Inert Sample Introduction System.

Description

Catalog No.

Mini X-Flow Nebulizer	020-060-611
Cross Flow Nebulizer for 35 mm Spray Chamber	020-060-603
Cross Flow Nebulizer for SPECTRO	020-060-606



Cross Flow Nebulizer,
020-060-603



ACCESSORIES



O-ring, for SPECTRO
Cross-Flow
020-050-224

Description

Catalog No.

O-ring, Viton® for Cross-Flow Nebulizer	020-050-147
Sample tube for Cross-Flow Nebulizer	020-050-148
Argon Fitting for Cross-Flow Nebulizer	020-050-149
O-ring, Viton® spray chamber side	020-050-222
O-ring, for SPECTRO Cross-Flow	020-050-224
O-ring for Mini-X Flow Nebulizer	020-060-610
PE® / SPECTRO Gas Adapter	020-060-651
Thermo® Gas Adapter	020-060-652
Sciex / PE®3000 gas Adapter	020-060-653
Agilent® / HP® Gas Adapter	020-060-654

Nebulizer CONCENTRIC



CONNECTORS AND TUBING INCLUDED WITH EACH NEBULIZER

Dr. James E. Meinhard began fabricating concentric glass nebulizers for ICP Spectroscopy during the technique's infancy in 1973. The first model featured a lapped, coplanar Type A nozzle and remains popular for use in general ICP applications. In 1983, Meinhard® introduced the Type C nebulizer for the analysis of samples high in dissolved solids. The Type K, designed to conserve argon, was developed in conjunction with an instrument manufacturer the following year.

Advantages include free aspiration without a peristaltic pump as well as a reproducible and self-aligning aerosol. Concentric nebulizers have traditionally been a preferred choice of spectroscopist seeking low RSD and detection limits.

SPECIFICATIONS



Configurations:	Concentric, monolithic
Materials:	Borosilicate Glass or Quartz
Tubulation Outer Diameter (O.D.)	Shell, 6 mm; fluid inputs, 4 mm
Nozzles:	A, C or K, see selection guide (above)
Internal Liquid Volume	0.1 ml
Annular Separation at Nozzle	10 - 30 µm
Calibration :	Provided with each unit: <ul style="list-style-type: none"> • P_c: Calibration input pressure at rated argon flow • Nominal P_c: (20, 30 or 50 psi) • R_a: Water uptake at P_c • Nominal R_a: (0.5, 1,2 or 3 ml/min)

Type	Type A	Type C	Type K
End surfaces	Lapped	Fire-polished	Lapped
Capillary tip recess	None, Coplanar	0.5 mm	0.5 mm
Uptake suction, atm	+	+	+
Calibration reference, Ar in L/min.	1.0	1.0	0.7
Stability of aerosol delivery	+	+	+
Popular ICP applications	General	High-Solids	Ar Low-Flow

Nebulizer CONCENTRIC

Nebulizers	Materials	P _c Range (psi)	R _a Range (ml/min)	Catalog No.
A Type (0.5)	Glass	25-40	0.3-0.6	020-060-014
A Type (1)	Glass	25-40	0.7-1.4	020-060-041
A Type (2)	Glass	25-40	1.5-2.4	020-060-001
A Type (2)	Quartz	25-40	1.5-2.4	020-060-011
A Type (3)	Glass	25-40	2.5-3.5	020-060-002
A Type (3)	Quartz	25-40	2.5-3.5	020-060-012
C Type (0.2)	Glass	25-40	0.1-0.4	020-060-023
C Type (0.5)	Glass	25-40	0.3-0.6	020-060-018
C Type (0.5)	Glass	41-60	0.3-0.6	020-060-004
C Type (1)	Glass	25-40	0.7-1.4	020-060-003
C Type (1)	Glass	25-40	0.7-1.4	020-060-613
C Type (1)	Quartz	25-40	0.7-1.4	020-060-016
C Type (1)	Glass	41-60	0.7-1.4	020-060-005
C Type (1)	Quartz	41-60	0.7-1.4	020-060-013
C Type (2)	Glass	25-40	1.5-2.4	020-060-006
C Type (2)	Quartz	25-40	1.5-2.4	020-060-017
C Type (3)	Glass	25-40	2.5-3.5	020-060-007
K Type (1)	Quartz	25-40	0.7-1.4	020-060-024
K Type (2)	Glass	25-40	1.0-2.2	020-060-008
K Type 3)	Glass	25-40	2.3-4.0	020-060-009
Aerosalt	Glass	25-40	1.5-2.4	020-060-608

P_c = Argon Pressure (psi)

R_a = Sample Uptake (ml/min)



ACCESSORIES

Description	Catalog No.
Swagelok Fitting, Concentric Nebulizer Sample	020-050-146
Viton® O-ring, Nebulizer side	020-050-504

Nebulizer QUICK CONNECT KIT

Damaged nebulizers and bruised knuckles are a thing of the past with Quick Connect Kits for nebulizers. These kits make switching out nebulizers fast and easy. Quick Connect Kits are available for all styles of Meinhard® Nebulizers.

Type	Description	Function	Catalog No.
High Pressure Gas Connection SCP Quick Fit Kit - HP® Gas	This Kit ties in the gas flow to the nebulizer. The union connects to the ¼" high pressure argon supply line. This fitting easily holds up to 190 psi.	Clamps / Connectors	020-060-052
4 mm Liquid Connection SCP Quick Fit Kit - Liquid	This kit is designed to tie into all concentric glass nebulizers with a 4 mm input tube for the sample or pump.	Clamps / Connectors	020-060-053

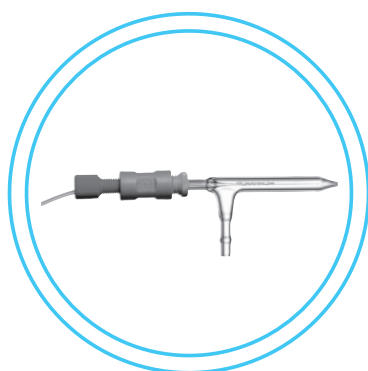

4 mm Liquid Connection

020-060-053

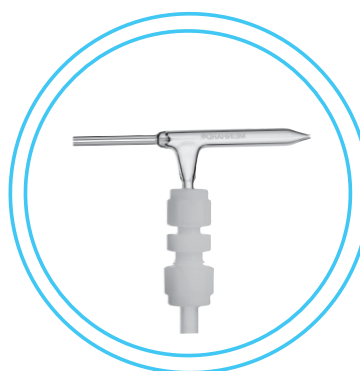

High Pressure Gas Connection

020-060-052

FREE

FREE PROMOTIONAL ITEM

WITH EVERY SPRAY CHAMBER OR TORCH!

CONTACT OUR SALES DEPARTMENT

FOR MORE INFORMATION SALES@SCPSCIENCE.COM

Nebulizer

PARALLEL PATH BURGNER

Burgener Nebulizers are made with the patented enhanced parallel path method enabling them to run high total dissolved solids (TDS) while providing excellent sensitivity and stability. Direct replacement for concentric nebulizers and fit cyclonic spray chambers.

Features

- Provide excellent sensitivity with high transport rates
- Eliminate plugs due to salt or undissolved particles
- Resistant to HF

CROSS REFERENCE

SCP SCIENCE	Thermo [®]	Agilent [®]	PERKINELMER [®]	SPECTRO	JY [®]
Mira Mist [®] , Teflon [®]	---	G3161A#001	---	---	---
Mira Mist [®] , PEEK	4600356	G3161A#002	N0775330	---	47.929.024
Ari Mist [®]	4600495	---	---	---	---
T2002 [®]	---	---	---	76060534	---



Mira Mist[®], PEEK
020-060-308

Nebulizers	P _c Range	R _a Range	Body	Catalog No.
Ari Mist [®] HP [®]	80	0.005-1.0	PEEK	020-060-307
Ari Mist [®] , LP	40-50	0.05-1.0	PEEK	020-060-314
Ari Mist [®] , Teflon [®] LP	40-50	0.05-1.0	PEEK	020-060-316
Mira Mist [®] , Teflon [®]	35-45	0.2-2.5	Teflon [®]	020-060-306
Mira Mist [®] , PEEK	35-45	0.2-2.5	PEEK	020-060-308
Mira Mist [®] , Graphite HS	35-45	0.2-2.5	Teflon [®]	020-060-310
Mira Mist [®] , CE	70-90	0.005-2.5	PEEK	020-060-312
Burgener T2002 [®]	35-45	0.5-3.0	Teflon [®]	020-060-301
Burgener T2100 [®]	35-45	0.5-2.0	Teflon [®]	020-060-318

P_c = Argon Pressure (psi)

R_a = Sample Uptake (ml/min)

Accessories

Accessories	Catalog No.
Fitting, Yellow, for Mira Mist [®] Nebulizer	020-060-039
Blue Sample fitting, for Burgener nebulizers	020-060-066
Red Ari Mist [®] fitting with red PTFE sample tubing	020-060-382

Nebulizer MODIFIED LICHTE

Studies performed on both radial (SPECTRO Modula ICP) and axial (SPECTRO EOP) ICP-AES instruments indicate that a 2-3 time improvement in sensitivity (and detection limits) can be obtained by changing from the conventional concentric nebulizer and Scott double-pass spray chamber arrangement to a Modified Lichte Nebulizer (MLN) and Cyclonic Spray Chamber.

The modified Lichte Nebulizer incorporates double bore glass tubing with an impact bead for fine aerosol dispersion. Operating principles are similar to that of the V-groove design where the face of the nebulizer encounters a high velocity stream of argon gas which converts the sample into a fine aerosol. This novel design allows improved detection limits over standard pneumatic nebulizers while allowing solutions containing higher dissolved solids to be run without clogging.



Nebulizer	Catalog No.
Nebulizer, Modified Lichte for SPECTRO	020-060-118
Nebulizer, Modified Lichte for PerkinElmer®	020-060-120

NOORDERMEER AND V-GROOVE

Noordermeer Nebulizer, fits standard 6 mm spray chamber or a Scott spray chamber with Teflon® End cap. A practical choice for samples containing high solids.

Babbington V-Groove Nebulizer, ½" diameter, for use with Hydrofluoric (HF) acid and samples containing high solids. Use with an End cap.

Type	Description	Catalog No.
Noordermeer	Nebulizer, w/o fitting	020-060-001
	Nebulizer, with fitting	020-060-002
	Teflon® End Cap, 34 mm for 6mm	020-050-212
V-Groove	Nebulizer	020-060-605
	Nebulizer, High Solids	020-060-607
	Nebulizer with Quick Disconnect	020-060-614
	Sample Tube, Babb. neb (2 Ft)	020-050-150
	Viton® O-ring, Babb. (pk/4)	020-050-220
	Teflon® End Cap, 34 mm for 6mm	020-050-212

ICP-MS CONES

PlasmaFORM cones are an attractive alternative to the traditional method of manufacturing ICP-MS cones. Rather than being manufactured on CNC Lathe-manufactured equipment, **PlasmaFORM** cones are manufactured by the electroforming process. Electroformed cones provides superior performance through a more perfect finish (no machining defects) and through better heat transfer. Electro-formed cones are standard OEM-issue for many ICP-MS manufactureres.

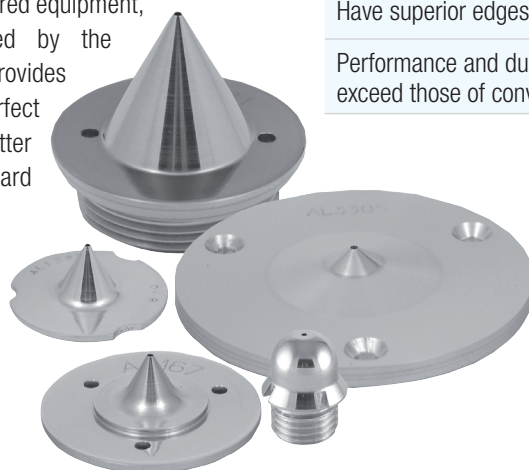

Features

Have superior edges and internal geometry than CNC cones

Performance and durability have been proven to equal or exceed those of conventionally manufactured cones

AGILENT®

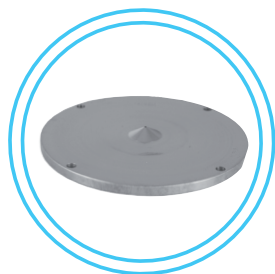

Cone, Sampler, Ni,
HP®4500/7500, (25mm)
020-107-051

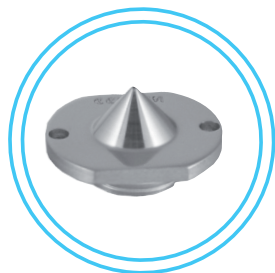

Cone, Skimmer, Ni,
HP®4500
020-107-052

Description	OEM X-ref Number	Catalog No.
Cone, Skimmer, Nickel, Agilent® 7500C	G183365497	020-102-054
Cone, Skimmer, Nickel, for 7500CE/CX	G327065024	020-102-056
Cone, Skimmer, Ni, 7500 a/i/s	G182065050	020-102-057
Cone, Skimmer, Pt, 7500 a/i/s	G182065207	020-102-059
Cone, Skimmer, Pt, 7500cs	G327060106	020-102-070
Cone, Skimmer, Pt, (Cu Base), 7500cs/ce	G183365132	020-102-071
Cone, Sampler, Ni/Cu, 7700 (unplated)	G328067040	020-102-073
Cone, Skimmer, Ni 7700x	G328067041	020-102-074
Cone, Skimmer, Ni 7700s	G328067066	020-102-075
Sampling Cone, Ni 7700 (plated)	G328067061	020-102-076
Cone, Skimmer, Pt, 7700s	G328067064	020-102-077
Cone, Skimmer, Pt, 7700x	G328067060	020-102-078
Cone, Skimmer, Pt, Ni Base, 7700	G328067063	020-102-079
Cone, Sampler, Pt, 7700	G328067036	020-102-080
Cone, Skimmer, Pt, Agilent® 7500C	G183365092	020-102-154
Cone, Sampler, Ni, HP®4500/7500, (25mm)	G182065238	020-107-051
Cone, Skimmer, Ni, HP®4500	G182065265	020-107-052
Cone, Sampler, Pt, HP®4500/7500 (10mm)	G182065239	020-107-151
Cone, Skimmer, Pt, HP®4500 (7.2mm)	G182065237	020-107-152

ICP-MS Cones

PERKINELMER® SERIES

Description	OEM X-ref Number	Catalog No.
Cone, Sampler, Ni, PE®5000	WE013087	020-101-062
Cone, Skimmer, Ni, PE®5000	N8122000	020-101-063
Cone, Sampler, Ni, PE® ELAN 9000/6X00/DRC	WE021140	020-101-064
Cone, Skimmer, Ni, PE® ELAN 9000/6X00/DRC	WE021137	020-101-065
Cone, Sampler, Pt, PE® ELAN 9000/6X00/DRC	WE014815 / WE027802	020-101-164
Cone, Skimmer, Pt, PE® ELAN 9000/6X00/DRC	WE014816 WE027803	020-101-165
Cone, Hyper Skimmer, Ni for PE® NexION	W1033995	020-101-070
Cone, Skimmer, Ni for PE® NexION	W1026356	020-101-072
Cone, Sampler, Ni for PE® NexION	W1033612	020-101-074
Cone, Skimmer, Pt for PE® NexION	W1026907	020-101-076
Cone, Sampler, Pt for PE® NexION	W1033614	020-101-078

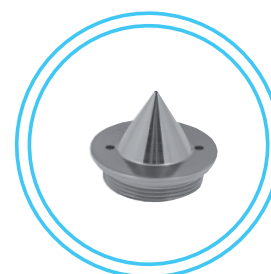

Cone, Skimmer, Ni,
PE® ELAN 9000/6X00/DRC
020-101-065

THERMO® VG SERIES

Description	OEM X-ref Number	Catalog No.
Cone, Skimmer, Nickel (18mm) PS8R (50/30)	3600811	020-104-020
Cone, Sampler, Nickel (4450)	3600812	020-104-022
Cone, Sampler, Platinum, Xs/Xt	3601289	020-104-028
Cone, Sampler, Ni, VG, with Fixing Holes	3004661 / 4001690	020-106-070
Cone, Skimmer, Mini, Ni, Thermo®	3004866 / 4001689	020-106-071
Cone, Skimmer, Micro, Ni, Thermo®	3200860 / 4200846	020-106-072
Cone, Skimmer, Micro, Ni, PT2	3200456 / 3201457	020-106-074
Cone, Skimmer, Ni, VG, 0.4mm)	3201585	020-106-075
Cone, Sampler, Ni, VG, w/o Fixing Holes	---	020-106-078
Cone, Sampler, Pt, VG (6.35mm)	3200262	020-106-170
Cone, Skimmer, Micro, Pt, VG	3201101	020-106-172
Cone, Skimmer, Micro, Pt, PT2	3201941	020-106-174
Cone, Screen, Slide, Ni, 3204004	3204004	020-106-190
Cone, Screen, Slide, Ni, 3204269	3204269	020-106-192
Cone, Transfer, Ni Earth, 3204486	3204486	020-106-194



Cone, Sampler, Ni,
VG, with Fixing Holes
020-106-070

ICP-MS Cones

THERMO® FINNIGAN SERIES

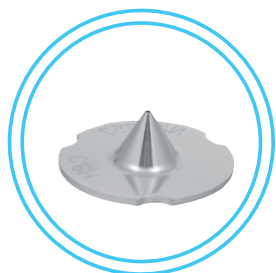

Cone, Skimmer, Nickel
020-102-051

Description	OEM X-ref Number	Catalog No.
Cone, Sampler, Nickel	1044530	020-102-050
Cone, Skimmer, Nickel	1044540	020-102-051
Cone, Skimmer, Nickel, High Performance	1067600	020-102-052
Cone, Skimmer, Pt	1067510	020-102-061
Cone, Skimmer, Ni, X	1142160	020-102-067
Cone, Skimmer, Pt, X	1142150	020-102-069
Cone, Sampler, Pt	1067500	020-102-150
Cone, Skimmer, Pt, High Performance	1047460	020-102-151
Cone, Sampler, Aluminum	1044530al	020-102-250
Cone, Skimmer, Al ,High Performance	1067600al	020-102-251

ANALYTIK JENA (VARIAN®) 800-MS SERIES



Cone, Skimmer, Nickel
020-107-072

Description	OEM X-ref Number	Catalog No.
Cone, Sampler, Nickel, F-Series	9910094000	020-107-070
Cone, Skimmer, Nickel, F-Series	9910094100	020-107-072

FREE

FREE PROMOTIONAL ITEM

WITH EVERY PURCHASE OF AN
SCP SCIENCE *PlasmaFORM* CONE
CONTACT OUR SALES DEPARTMENT
FOR MORE INFORMATION SALES@SCPSCIENCE.COM

PERISTALTIC PUMP TUBING

SCP SCIENCE offers a complete range of affordable and reliable peristaltic pump tubing including: PHTHALATE-FREE PVC, Solvent Flex, Silicone, Viton®, and Santoprene® compositions. Tested and certified for chemical composition, performance and durability, simply choose the proper color, inner diameter (I.D.), and number of “stops” to confirm the right pump tubing. Can't find exactly what you're looking for? Additional and custom sizes are available. Contact your sales representative.



FLARED PERISTALTIC PUMP TUBING

With traditional tubing, it can be difficult to insert the sample tube into the pump tube - especially when working with different inner diameters (IDs). With this new product, the tubing is flared at the end, letting you use the ID you require while providing an opening wide enough to easily insert a larger - diameter sample tube.

Don't require the flare for a particular application? Simply cut the end off of the tubing.

MIXING KITS

Description	Catalog No.
TJA Internal Std Mix Kit (pk/4)	020-049-601
PE Sciex Internal Std Mix Kit (pk/4)	020-049-603
Varian Internal Std Mix Kit (pk/4)	020-049-604
Varian Internal Std Mix Kit (pk/4) Org.	020-049-605
Internal Std Mix Kit #2, 2 Stop (pk/4)	020-049-606
Varian Vista mixing kit (pk/4) Viton	020-049-609

Mixing kits are designed to accommodate the automated addition of either an internal standard or ionization suppression solution by means of a metered flow and mixing through peristaltic pump tubing.

The mixing kit will provide an appropriate sample dilution for your needs. Consult your ICP Spectrometer documentation for the appropriate concentration for the Internal Standard Solution.

Peristaltic Pump Tubing

CHEMICAL RESISTANCE

Chemical compatibility varies between different materials and solution. For example, Viton® tubing is resistant to many inorganic chemicals and even to some organic solvents. The chemical resistance table will help choose the correct pump tubing material for your application. Contact your Sales Representative or local distributor to inquire about the right pump tubing.

Chemical Classification	PVC	Solvent Flex	Silicone	Viton®	Santoprene®
Acetone	U	U	X	U	U
Alcohols	X	X	X	X	---
Aliphatic Hydrocarbons	U	X	U	U	---
Aqua Regia	U	X	---	O	U
Aromatic Hydrocarbons	U	U	O	X	---
Gasoline (non-aromatic)	U	U	U	X	U
Gasoline (high aromatic)	U	U	U	X	---
Hydrochloric Acid (diluted)	X	X	U	X	X
Kerosene	U	U	U	X	U
Ketones (MIBK)	U	U	U	U	X
Nitric Acid (diluted)	X	X	O	X	O
Oils, Animal	U	X	O	X	X
Oils, Mineral	U	X	O	X	X
Oils, Vegetable	O	X	X	X	X
Premisolv™	U	X	O	X	U
Sulfuric Acid (diluted)	X	X	U	X	O
Water	X	X	X	X	X
Xylene	U	U	U	X	U



Legend

X	Satisfactory
O	Use only after testing
U	Unsatisfactory
---	No data available



15 TUBES FOR THE PRICE OF 12

CONTACT OUR SALES DEPARTMENT
FOR MORE INFORMATION SALES@SCPSCIENCE.COM

Pump Tubing

PHTHALATE-FREE PVC

PVC pump tubing is the standard choice for most inorganic analysis due to its strong acid resistance and elasticity, which provides for good longevity. Consult the Chemical Resistance chart on page 112.

2 STOP

Color Code		ID (mm)	STANDARD 150mm INTER-STOP		MICRO 72mm INTER-STOP	
			REGULAR Catalog Number (pack of 15 tubes)	FLARED Catalog Number (pack of 15 tubes)	REGULAR Catalog Number (pack of 15 tubes)	FLARED Catalog Number (pack of 15 tubes)
BLACK	BLACK	0.76	022-030-007	022-130-007	023-030-007	023-130-007
BLACK	WHITE	3.18	022-030-021	022-130-021	023-030-021	023-130-021
BLUE	BLUE	1.65	022-030-013	022-130-013	023-030-013	023-130-013
BLUE	GREEN	1.75	022-030-022	022-130-022	023-030-022	023-130-022
GRAY	GRAY	1.30	022-030-011	022-130-011	023-030-011	023-130-011
GREEN	GREEN	1.85	022-030-014	022-130-014	023-030-014	023-130-014
GREEN	YELLOW	0.44	022-030-024	022-130-024	023-030-024	023-130-024
ORANGE	BLUE	0.25	022-030-003	022-130-003	023-030-003	023-130-003
ORANGE	GREEN	0.38	022-030-004	022-130-004	023-030-004	023-130-004
ORANGE	ORANGE	0.89	022-030-008	022-130-008	023-030-008	023-130-008
ORANGE	RED	0.19	022-030-002	022-130-002	023-030-002	023-130-002
ORANGE	WHITE	0.64	022-030-006	022-130-006	023-030-006	023-130-006
ORANGE	YELLOW	0.51	022-030-005	022-130-005	023-030-005	023-130-005
PURPLE	BLACK	2.29	022-030-016	022-130-016	023-030-016	023-130-016
PURPLE	ORANGE	2.54	022-030-017	022-130-017	023-030-017	023-130-017
PURPLE	PURPLE	2.06	022-030-015	022-130-015	023-030-015	023-130-015
PURPLE	WHITE	2.79	022-030-018	022-130-018	023-030-018	023-130-018
RED	RED	1.14	022-030-010	022-130-010	023-030-010	023-130-010
WHITE	BLACK	0.95	022-030-023	022-130-023	023-030-023	023-130-023
WHITE	WHITE	1.02	022-030-009	022-130-009	023-030-009	023-130-009
YELLOW	BLUE	1.52	022-030-019	022-130-019	023-030-019	023-130-019
YELLOW	YELLOW	1.42	022-030-012	022-130-012	023-030-012	023-130-012

Pump Tubing

PHTHALATE-FREE PVC

3 STOP

STANDARD - 72mm INTER-STOP					
Color Code			ID (mm)	REGULAR Catalog Number (pack of 15 tubes)	FLARED Catalog Number (pack of 15 tubes)
BLACK	BLACK	BLACK	0.76	022-033-007	022-133-007
BLACK	WHITE	BLACK	3.18	022-033-021	022-133-021
BLUE	BLUE	BLUE	1.65	022-033-013	022-133-013
GRAY	GRAY	GRAY	1.30	022-033-011	022-133-011
GREEN	GREEN	GREEN	1.85	022-033-014	022-133-014
ORANGE	BLUE	ORANGE	0.25	022-033-003	022-133-003
ORANGE	GREEN	ORANGE	0.38	022-033-004	022-133-004
ORANGE	ORANGE	ORANGE	0.89	022-033-008	022-133-008
ORANGE	RED	ORANGE	0.19	022-033-002	022-133-002
ORANGE	WHITE	ORANGE	0.64	022-033-006	022-133-006
ORANGE	YELLOW	ORANGE	0.51	022-033-005	022-133-005
PURPLE	PURPLE	PURPLE	2.06	022-033-015	022-133-015
PURPLE	ORANGE	PURPLE	2.54	022-033-017	022-133-017
PURPLE	WHITE	PURPLE	2.79	022-033-018	022-133-018
RED	RED	RED	1.14	022-033-010	022-133-010
WHITE	BLACK	WHITE	0.95	022-033-023	022-133-023
WHITE	WHITE	WHITE	1.02	022-033-009	022-133-009
YELLOW	BLUE	YELLOW	1.52	022-033-019	022-133-019
YELLOW	YELLOW	YELLOW	1.42	022-033-012	022-133-012

SAMPLE / DRAIN TUBING

Description	ID (mm)	Length	Catalog Number
PVC Tubing	0.19	15 m	020-039-005
Polypropylene tubing, OD 1.0mm	0.6	30 m	020-039-403
PVC Tubing	0.64	15 m	020-039-002
PVC Tubing	1.14	15 m	020-039-012
PVC Tubing	1.52	15 m	020-039-001
PVC Tubing	2.29	15 m	020-039-004
PVC Tubing	2.79	15 m	020-039-007

Pump Tubing SOLVENT FLEX

Solvent Flex tubing is the ideal choice for analysis of organics with the exception of the most aggressive solvents. Combining strong resistance to most diluents with good elasticity, provides excellent value. Consult the Chemical Resistance chart on page 112.

2 STOP

Color Code	ID (mm)	STANDARD 140mm INTER-STOP		MICRO 72mm INTER-STOP		
		REGULAR Catalog Number (pack of 15 tubes)	FLARED Catalog Number (pack of 15 tubes)	REGULAR Catalog Number (pack of 15 tubes)	FLARED Catalog Number (pack of 15 tubes)	
BLACK	BLACK	0.76	022-030-107	022-130-107	023-030-107	023-130-107
BLACK	WHITE	3.18	022-030-121	022-130-121	023-030-121	023-130-121
BLUE	BLUE	1.65	022-030-113	022-130-113	023-030-113	023-130-113
BLUE	GREEN	1.75	022-030-122	022-130-122	023-030-122	023-130-122
GRAY	GRAY	1.30	022-030-111	022-130-111	023-030-111	023-130-111
GREEN	GREEN	1.85	022-030-114	022-130-114	023-030-114	023-130-114
ORANGE	BLUE	0.25	022-030-103	022-130-103	023-030-103	023-130-103
ORANGE	GREEN	0.38	022-030-104	022-130-104	023-030-104	023-130-104
ORANGE	ORANGE	0.89	022-030-108	022-130-108	023-030-108	023-130-108
ORANGE	RED	0.19	022-030-102	022-130-102	023-030-102	023-130-102
ORANGE	WHITE	0.64	022-030-106	022-130-106	023-030-106	023-130-106
ORANGE	YELLOW	0.51	022-030-105	022-130-105	023-030-105	023-130-105
PURPLE	BLACK	2.29	022-030-116	022-130-116	023-030-116	023-130-116
PURPLE	ORANGE	2.54	022-030-117	022-130-117	023-030-117	023-130-117
PURPLE	PURPLE	2.06	022-030-115	022-130-115	023-030-115	023-130-115
PURPLE	WHITE	2.79	022-030-118	022-130-118	023-030-118	023-130-118
RED	RED	1.14	022-030-110	022-130-110	023-030-110	023-130-110
WHITE	WHITE	1.02	022-030-109	022-130-109	023-030-109	023-130-109
YELLOW	BLUE	1.52	022-030-119	022-130-119	023-030-119	023-130-119
YELLOW	YELLOW	1.42	022-030-112	022-130-112	023-030-112	023-130-112

SAMPLE / DRAIN TUBING

Description	ID (mm)	Length	Catalog Number
Polypropylene tubing OD 1.0mm	0.6	30 m	020-039-403
Solvent flex tubing	0.76	15 m	020-039-010
Solvent flex tubing	1.14	15 m	020-039-011
Solvent flex tubing	1.52	15 m	020-039-009

Pump Tubing

SOLVENT FLEX

3 STOP REGULAR

STANDARD - 81mm INTER-STOP				
Color Code			ID (mm)	Catalog Number (pack of 15 tubes)
BLACK	BLACK	BLACK	0.76	022-033-107
BLUE	BLUE	BLUE	1.65	022-033-113
GRAY	GRAY	GRAY	1.30	022-033-111
ORANGE	BLUE	ORANGE	0.25	022-033-103
ORANGE	GREEN	ORANGE	0.38	022-033-104
ORANGE	ORANGE	ORANGE	0.89	022-033-108
ORANGE	RED	ORANGE	0.19	022-033-102
PURPLE	PURPLE	PURPLE	2.06	022-033-115
PURPLE	WHITE	PURPLE	2.79	022-033-118
RED	RED	RED	1.14	022-033-110
WHITE	WHITE	WHITE	1.02	022-033-109
YELLOW	BLUE	YELLOW	1.52	022-033-119
YELLOW	YELLOW	YELLOW	1.42	022-033-112

72mm INTER-STOP				
Color Code			ID (mm)	Catalog Number (pack of 15 tubes)
BLUE	BLUE	BLUE	1.65	022-034-113
ORANGE	ORANGE	ORANGE	0.89	022-034-108
PURPLE	PURPLE	PURPLE	2.06	022-034-115
RED	RED	RED	1.14	022-034-110
YELLOW	BLUE	YELLOW	1.52	022-034-119
YELLOW	YELLOW	YELLOW	1.42	022-034-112

67mm INTER-STOP				
Color Code			ID (mm)	Catalog Number (pack of 15 tubes)
BLUE	BLUE	BLUE	1.65	022-035-113
PURPLE	PURPLE	PURPLE	2.06	022-035-115
YELLOW	BLUE	YELLOW	1.52	022-035-119
YELLOW	YELLOW	YELLOW	1.42	022-035-112

Pump Tubing SANTOPRENE®

Santoprene® biocompatible pump tubing, equivalent to Pharmed, Marprene & Duraprene, is the first choice for laboratories performing biological analysis and other medical applications. Consult the Chemical Resistance chart on page 112.

2 STOP REGULAR

STANDARD - 150mm INTER-STOP			
Color Code		ID (mm)	Catalog Number (pack of 15 tubes)
BLACK	BLACK	0.76	022-030-407
BLUE	BLUE	1.65	022-030-413
GRAY	GRAY	1.30	022-030-411
GREEN	GREEN	1.85	022-030-414
ORANGE	BLUE	0.25	022-030-403
ORANGE	GREEN	0.38	022-030-404
ORANGE	ORANGE	0.89	022-030-408
ORANGE	WHITE	0.64	022-030-406
ORANGE	YELLOW	0.51	022-030-405
PURPLE	BLACK	2.29	022-030-416
PURPLE	PURPLE	2.06	022-030-415
PURPLE	WHITE	2.79	022-030-418
RED	RED	1.14	022-030-410
WHITE	WHITE	1.02	022-030-409
YELLOW	BLUE	1.52	022-030-419
YELLOW	YELLOW	1.42	022-030-412

3 STOP REGULAR

STANDARD - 72mm INTER-STOP				
Color Code			ID (mm)	Catalog Number (pack of 15 tubes)
BLUE	BLUE	BLUE	1.65	022-033-413
GRAY	GRAY	GRAY	1.30	022-033-411
ORANGE	ORANGE	ORANGE	0.89	022-033-408
ORANGE	YELLOW	ORANGE	0.51	022-033-405
PURPLE	PURPLE	PURPLE	2.06	022-033-415
PURPLE	BLACK	PURPLE	2.29	022-033-416
PURPLE	WHITE	PURPLE	2.79	022-033-418
RED	RED	RED	1.14	022-033-410
WHITE	WHITE	WHITE	1.02	022-033-409
YELLOW	BLUE	YELLOW	1.52	022-033-419
YELLOW	YELLOW	YELLOW	1.42	022-033-412

2 STOP MICRO

MICRO - 72mm INTER-STOP			
Color Code		ID (mm)	Catalog Number (pack of 15 tubes)
BLACK	BLACK	0.76	023-030-407
BLACK	WHITE	3.17	023-030-421
GRAY	GRAY	1.30	023-030-411
ORANGE	GREEN	0.38	023-030-404
YELLOW	BLUE	1.52	023-030-419

SAMPLE / DRAIN TUBING

Description	ID (mm)	Length	Catalog Number
Santoprene tubing	1.6	30 m	020-039-401
Santoprene tubing, OD 9.5mm	6.4	15 m	020-039-402
Polypropylene tubing OD 1.0mm	0.6	30 m	020-039-403

Pump Tubing

VITON®

The extreme resistance of Viton® to strong acids and aggressive solvents, make Viton® the ideal choice when analyzing solutions that are too strong for other materials. Consult the Chemical Resistance chart on page 112.

2 STOP REGULAR

STANDARD - 127mm INTER-STOP			
Color Code		ID (mm)	Catalog Number (pack of 15 tubes)
BLACK	BLACK	0.76	022-030-307
BLUE	BLUE	1.65	022-030-313
GRAY	GRAY	1.30	022-030-311
GREEN	GREEN	1.85	022-030-314
ORANGE	ORANGE	0.89	022-030-308
ORANGE	WHITE	0.64	022-030-306
ORANGE	YELLOW	0.51	022-030-305
PURPLE	BLACK	2.29	022-030-316
PURPLE	ORANGE	2.54	022-030-317
PURPLE	PURPLE	2.06	022-030-315
PURPLE	WHITE	2.79	022-030-318
RED	RED	1.14	022-030-310
WHITE	WHITE	1.02	022-030-309
YELLOW	BLUE	1.52	022-030-319
YELLOW	YELLOW	1.42	022-030-312

STANDARD - 140mm INTER-STOP			
Color Code		ID (mm)	Catalog Number (pack of 15 tubes)
BLACK	BLACK	0.76	022-031-307
RED	RED	1.14	022-031-310

3 STOP REGULAR

STANDARD - 82mm INTER-STOP					STANDARD - 72mm INTER-STOP				
Color Code			ID (mm)	Catalog Number (pack of 15 tubes)	Color Code			ID (mm)	Catalog Number (pack of 15 tubes)
BLACK	BLACK	BLACK	0.76	022-033-307	ORANGE	ORANGE	ORANGE	0.89	022-033-328
BLUE	BLUE	BLUE	1.65	022-033-313	RED	RED	RED	1.14	022-033-320
GREEN	GREEN	GREEN	1.85	022-033-314	YELLOW	YELLOW	YELLOW	1.42	022-033-322
ORANGE	ORANGE	ORANGE	0.89	022-033-308					
ORANGE	YELLOW	ORANGE	0.51	022-033-305					
PURPLE	BLACK	PURPLE	2.29	022-033-316					
PURPLE	ORANGE	PURPLE	2.54	022-033-317					
PURPLE	PURPLE	PURPLE	2.06	022-033-315					
RED	RED	RED	1.14	022-033-310					
WHITE	WHITE	WHITE	1.02	022-033-309					
YELLOW	BLUE	YELLOW	1.52	022-033-319					
YELLOW	YELLOW	YELLOW	1.42	022-033-312					

Pump Tubing

SILICONE

Silicon peristaltic pump tubing provides excellent repeatability and longevity, though limited in number of applications due to chemical resistance. Consult the Chemical Resistance chart on page 112.

3 STOP REGULAR

STANDARD - 67mm INTER-STOP

Color Code			ID (mm)	Catalog Number (pack of 15 tubes)
BLACK	BLACK	BLACK	0.76	022-033-207
GREEN	GREEN	GREEN	1.85	022-033-214
ORANGE	ORANGE	ORANGE	0.89	022-033-208
ORANGE	WHITE	ORANGE	0.64	022-033-206
PURPLE	BLACK	PURPLE	2.29	022-033-216
PURPLE	ORANGE	PURPLE	2.54	022-033-217
PURPLE	PURPLE	PURPLE	2.06	022-033-215
PURPLE	WHITE	PURPLE	2.79	022-033-218
RED	RED	RED	1.14	022-033-210
WHITE	WHITE	WHITE	1.02	022-033-209
YELLOW	BLUE	YELLOW	1.52	022-033-219
YELLOW	YELLOW	YELLOW	1.42	022-033-212

SAMPLE / DRAIN TUBING

Description	ID (mm)	Length (m)	Catalog Number
Silicone tubing, 1.6mm wall	4.8	15	020-039-013
Polypropylene tubing OD 1.0mm	0.6	30	020-039-403

2 STOP REGULAR

STANDARD - 140mm INTER-STOP

Color Code		ID (mm)	Catalog Number (pack of 15 tubes)
BLACK	BLACK	0.76	022-030-207
BLUE	BLUE	1.65	022-030-213
GRAY	GRAY	1.30	022-030-211
GREEN	GREEN	1.85	022-030-214
GREEN	YELLOW	0.44	022-030-224
ORANGE	GREEN	0.38	022-030-204
ORANGE	GREEN	0.38	022-030-205
ORANGE	ORANGE	0.89	022-030-208
ORANGE	RED	0.19	022-030-202
ORANGE	WHITE	0.64	022-030-206
PURPLE	BLACK	2.29	022-030-216
PURPLE	ORANGE	2.54	022-030-217
PURPLE	PURPLE	2.06	022-030-215
PURPLE	WHITE	2.79	022-030-218
RED	RED	1.14	022-030-210
WHITE	WHITE	1.02	022-030-209
YELLOW	BLUE	1.52	022-030-219
YELLOW	YELLOW	1.42	022-030-212



EXTRA PUMP TUBING IN EVERY PACK

CONTACT OUR SALES DEPARTMENT
FOR MORE INFORMATION SALES@SCPSCIENCE.COM

Pump Tubing

TUBING FOR LEEMAN® INSTRUMENTS

Color Code	Size	Quantity (tubes)	Leeman® Cross Reference	Catalog Number	
BLACK	6", 25 mm to stop	12	---	020-036-012	
BLUE	137 mm long, 25 mm to stop	12	309-00088-2	020-036-011	
BLUE	6", 25 mm to stop	12	---	020-036-014	
GRAY	400 mm long, 150 mm to stop	25	---	020-033-452	
GREEN	400 mm long, 150 mm to stop	25	---	020-033-450	
ORANGE	455 mm long, 140 mm to stop	12	---	020-036-108	
ORANGE	37.5" long, 19.5" to stop	12	309-3551	020-036-008	
RED	187 mm long, 25 mm to stop	12	309-00088-4	020-036-009	
RED	30" long, 12" to stop	12	309-3538	020-036-010	
BLACK	BLACK	Solvent Flex, 16.5 cm between stops, 30.5 cm in total	12	309-0069-2	020-037-005
RED	RED	Solvent Flex, 16.5 cm between stops, 30.5 cm in total	12	309-0069-8	020-037-007
YELLOW	ORANGE	Solvent Flex, 16.5 cm between stops, 30.5 cm in total	12	309-0069-5	020-037-010

AUTOSAMPLER TUBES



Description	Composition	Qty	Cross Reference	Catalog No.
1.5 ml Conical Sample Cups	Polystyrene	1000	B0119079	080-070-102
3.5 ml Conical Sample Cups	Polystyrene	1000	B0129303	080-070-103
15 ml DigiTUBE Autosampler Tubes, Round Bottom (17 x 100 mm)	Polypropylene	1000	n/a	010-515-607
Plug Stopper, 17 mm for 010-515-607	Polyethylene	1000	n/a	130-012-017
15 ml Conical Bottom Centrifuge Tubes (17 x 120 mm)	Polypropylene	1000	n/a	130-010-015
6 ml Round Bottom (13 x 100 mm)	Polypropylene	1000	B0193235	130-012-001
12 ml Round Bottom (16 x 100 mm)	Polypropylene	1000	n/a	130-012-006
15 ml Centrifuge Tube (17 x 120 mm)	Polypropylene	1000	N7301205	130-010-015
50 ml Conical Bottom, Centrifuge Tubes w/caps (29 x 118 mm)	Polypropylene	500	n/a	130-010-051
15 ml DigiTUBE with screw caps	Polypropylene	1620	n/a	010-515-263
50 ml DigiTUBE with screw caps	Polypropylene	1000	n/a	010-500-263